



OFERTAS Y PEDIDOS:

Las ofertas realizadas por GRUPO ALMAGROMUR S.L., están sujetas a confirmación salvo pacto en contrario por escrito. Las ofertas serán vinculantes para GRUPO ALMAGROMUR S.L. en las condiciones descritas en la oferta salvo, por falta de suministro, un incremento no previsto en los precios o por otra causa de fuerza mayor.

PRECIOS:

Serán los indicados en nuestra lista de precios (salvo errata de imprenta), en euros y sin I.V.A. después de aplicarle el descuento correspondiente en cada caso. Si existe oferta previa se considerará siempre ésta.

CONDICIONES DE PAGO:

Serán las condiciones generales de cada cliente o las particulares que se pacten por escrito en casos concretos. Asimismo, GRUPO ALMAGROMUR S.L., no aceptará prórrogas en el pago, siendo declarados a CREDITO Y CAUCION todos los retrasos.

SUMINISTRO Y TRANSPORTE:

El suministro de materiales se adecuará en todo lo posible a la conveniencia del cliente. GRUPO ALMAGROMUR S.L. no se responsabiliza de los suministros de mercancías, las cuales viajen por cuenta y riesgo del comprador (portes debidos). GRUPO ALMAGROMUR S.L. enviará los materiales por el medio y compañía de transporte que considere más conveniente.

GRUPO ALMAGROMUR S.L. enviarán los pedidos a portes pagados cuando estos superen los 800 euros netos.

DEVOLUCIONES DE MERCANCIA:

No se admitirán devoluciones de mercancía sin previo consentimiento del personal autorizado de GRUPO ALMAGROMUR S.L., por lo que sin dicha autorización se entenderá improcedente la devolución. Para la admisión de la mercancía deben darse las siguientes condiciones:

- No se admiten devoluciones transcurridos 15 días desde la entrega de material.
- No se aceptará material deteriorado, mal conservado, con marcas de haber estado en obra, etc.
- GRUPO ALMAGROMUR S.L. abonará solamente un 80% del valor de la mercancía devuelta reservándose el 20% restante en concepto de inspección, clasificación y reordenación de material.
- Todos los gastos de devolución del material serán por cuenta del cliente.
- No se aceptarán devoluciones de productos que se hayan fabricado específicamente para el cliente.

RESPONSABILIDAD DE PRODUCTO:

Se consideran defectos aquellos que se encuentren documentados, en diseño, proceso de fabricación o en calidad de materiales. No se considera defecto una mala instalación de las piezas, un daño por mal trato en el transporte, almacenamiento o montaje. Tampoco se considera defecto cuando la instalación tenga lugar en situaciones diferentes para las que se ha fabricado la pieza o las normas que aconsejan GRUPO ALMAGROMUR S.L.

El comprador debe hacer un examen razonable del producto inmediatamente después de su entrega, el comprador no podrá alegar ningún defecto que hubiera podido observarse al realizar tal examen, salvo que lo haya comunicado por escrito a GRUPO ALMAGROMUR S.L. en el plazo de 10 días desde su recepción.

GRUPO ALMAGROMUR S.L. atenderá la reclamación enviando unas piezas nuevas a la recepción de las que están defectuosas, o en un plazo razonable si no hay en stock. El comprador no tendrá derecho a ninguna otra compensación salvo las recogidas en la garantía del producto si la tuviere.

GRUPO ALMAGROMUR S.L. no se hará cargo de ningún gasto de agua, búsqueda de fugas, movimiento de tierras, demolición y reparación de pavimentos, etc., por causa de una pieza suministrada defectuosa ya que el instalador deberá realizar las pruebas de estanqueidad según el pliego de prescripciones técnicas del M.O.P.T. (capítulo 5, pruebas en las conducciones) a zanja parcialmente rellena y juntas descubiertas.

En ningún caso GRUPO ALMAGROMUR S.L. tomará a su cargo ninguna pérdida comercial de tiempo, de beneficio ni ninguna otra de cualquier tipo subsiguiente debida a los defectos.

De igual modo GRUPO ALMAGROMUR S.L. no será responsable de ningún tipo de contaminación causado al aire, tierra o agua o por medio de éstos así como de ningún daño causado a las cosas con finalidades comerciales. Tampoco será responsable de ningún daño causado a muebles, inmuebles o personas a causa del producto vendido mientras éste se encuentre en poder del comprador, no será responsable del daño originado en las instalaciones inmuebles, plantas industriales, etc. en las que estuviese colocado el producto defectuoso.

JURISDICCION:

Estas condiciones se consideran aceptadas por el cliente desde el momento en que realiza su pedido. Para cualquier cuestión que pueda derivarse de la relación comercial con la empresa, las partes se someten expresamente a los juzgados y tribunales de la ciudad de Murcia, renunciando a cualquier otro fuero que pudiera corresponderle.



	DTO
ABRAZADERAS DE REPARACIÓN "MODELO GA"	21
ACCESORIOS DE LATÓN PARA TUBERÍA DE HIERRO	41,42,43,44,45,46,47,48
ACCESORIOS DE LATÓN PARA TUBERÍA DE POLIETILENO	37,38,39,40
ACCESORIOS DE HIERRO GALVANIZADO	55,56,57,58,59,60
ACCESORIOS ELECTROSOLDABLE Y SOLDADURA TOPE	66,67,68,69,70,71
ACCESORIOS DE FUNDICIÓN DÚCTIL (JUNTA MECANICA Y BRIDA)	62,63,64,65
ACCESORIOS DE PRESIÓN ENCOLAR PVC	74,75,76,77,78
ACCESORIOS FITTING-HIDRO	82,83
ACCESORIOS PARA RAMALES DE MICROIRRIGACION	84
BOCAS DE RIEGO	8,9
BOCAS DE RIEGO DE LATÓN	43
BRIDA ANTI-TRACCIÓN "MODELO GA"	12
BRIDA DOBLE CAMARA FUNDICIÓN GRIS	19
BRIDA DOBLE CAMARA AUTOBLOCANTES "MODELO GA"	12
BRIDA MULTI-MEDIDA "MODELO GA"	11
BRIDA PLANA ACERO BISELADA	73
BRIDA PLANA ACERO PARA SOLDAR	72
BRIDA PLANA ACERO CIEGA	73
BRIDA PLANA ACERO ROSCADA	73
BRIDA PLANA ACERO PARA PORTABRIDA PVC	73
BRIDA PLANA ACERO PARA PORTABRIDA P.E.	72
BRIDAS REDUCTORAS	64
BRIDAS UNIVERSALES "MODELO GA"	11
CAÑAMO Y TEFLÓN	48
CARRETES DE DESMONTAJE	16
CONTADOR DE AGUA	9
COLLARINES DE HIERRO FUNDICIÓN GRIS PARA PVC Y F.C. "MODELO GA"	26,27,28
COLLARIN DE BANDA DE ACERO INOX. Y CABEZAL BRIDA / ROSCADO "MODELO GA"	29
COLLARIN DE FUNDICION EMBRIDADO PARA P.E. Y PVC "MODELO GA"	30
COLLARIN DE LATÓN	50
COLLARIN DE POLIPROPILENO CON FIBRA DE VIDRIO	85
COLLARIN DE REPARACIÓN ANTI-TRACCIÓN "MODELO GA"	12
COLLARIN TOMA DE FUNDICIÓN DÚCTIL, 4 TORNILLOS "MODELO GA"	30
ENLACE ROTULA ZINCADO	61
FILTROS DE HIERRO EN Y "MODELO GA"	17
FILTROS DE LATÓN EN Y	50
FILTRO ANILLAS PVC.....	80
GOMAS PARA U.G., BRIDAS DE DOBLE CAMARA Y COLLARINES.....	20
GRIFOS DE ESFERA	51
GRIFOS DE LATÓN	48
HIDRANTES.....	53,54
JUEGOS DE REGISTRO Y REJILLAS EN FUNDICIÓN GRIS	31,32,33,34
JUEGOS DE REGISTRO EN FUNDICIÓN NODULAR	35,36
JUNTAS PARA BRIDAS PLANAS DE NEOPRENO ADHESIVA Y TALADRADAS	7
LANZAS DE METAL PARA MANGUERA	45
MANGUITO ELÁSTICO Y MANGUITOS ELÁSTICOS ROSCADOS "MODELO GA"	13
MANGUITO PARA CAÑA GALVANIZADOS	56
MANÓMETROS	28



MASILLA –COLA-DISOLVENTE PARA PVC.....	81	
PATES DE POZO	48	
PROLONGADOR TELESCÓPICO PARA VÁLVULA COMPUERTA	3	
PUERTAS DE CONTADOR, REGISTRO Y SUMIDEROS DE ALUMINIO	33	
REDUCTORES DE PRESIÓN.....	52	
SUMIDERO DE PATIO, ACERO CINCADO Y ACERO INOX.	34	
TAPÓN UNIVERSAL “MODELO GA”	11	
TRAMPILLONES	3	
UNION ANTI-TRACCIÓN “MODELO GA”	11	
UNIÓN GIBAULT PARA PVC Y AROS LATERALES “MODELO GA”	18	
UNION GUIBAULT PARA PVC CON CARRETE DE PVC	19	
UNION GUIBAULT PARA FIBROCEMENTO	19	
UNIONES ARPOL	22	
UNIONES UNIVERSALES “MODELO GA”	10	
UNIONES MULTI-DIAMETRO Y GRAN TOLERANCIA “MODELO GA”	10	
UNION DE TRANSICIÓN AUTOBLOCANTE / UNIVERSAL “MODELO GA”	12	
VÁLVULAS DE COMPUERTA CIERRE ELÁSTICO, BRIDAS “MODELO GA”	1	
VÁLVULA DE COMPUERTA CIERRE ELÁSTICO, ENCHUFE PVC “MODELO GA”	1	
VÁLVULA DE COMPUERTA CIERRE ELÁSTICO CUELLO LISO	2	
VÁLVULA DE COMPUERTA CIERRE ELÁSTICO BRIDA PN-25 “MODELO GA”	2	
VÁLVULA DE COMPUERTA CIERRE METAL BRIDAS	2	
VÁLVULA DE GUILLOTINA TIPO WAFER	5	
VÁLVULA DE REGISTRO ROSCADA “MODELO GA”	2	
VÁLVULA DE BOLA P.V.C.	84	
VÁLVULA DE ESFERA ANTI-RETORNO	52	
VÁLVULAS DE ESFERA DE LATÓN ACC / PALANCA, MARIPOSA, CUADRADILLO	51	
VÁLVULA DE ESFERA DE BRONCE CON CUADRADILLO	49	
VÁLVULA DE LATÓN CIERRE ELÁSTICO	49	
VÁLVULA DE LATON CIERRE LATÓN	52	
VÁLVULA DE MARIPOSA VAMEIN	4	
VÁLVULA DE MARIPOSA P.V.C.	80	
VÁLVULA DE PIE DE FUNDICIÓN BRIDA	7	
VÁLVULA DE PIE Y RETENCIÓN DE LATÓN	49	
VÁLVULA DE PIE NETWELL PVC , ROSCA HEMBRA, ENCOLAR, NETVIC	79	
VÁLVULA DE PUENTE	5	
VÁLVULA DE RETENCIÓN BRIDAS CLAPETA OSCILANTE	7	
VÁLVULA DE RETENCIÓN DE BOLA BRIDAS Y ROSCADA “MODELO GA”	6	
VÁLVULA DE RETENCIÓN LATÓN TIPO YORK	50	
VÁLVULA DE RETENCIÓN LATÓN ROSCADA CLAPETA METAL	50	
VÁLVULA DE RETENCIÓN DE PVC "SYSTEM"	81	
VÁLVULA DE RETENCIÓN TIPO CHECK DOBLE Y SIMPLE DISCO “MODELO GA”	5,6	
VÁLVULA DE RETENCIÓN TIPO CHECK DOBLE DISCO PN-25	6	
VÁLVULA DE RETENCIÓN TIPO CHECK SERIE "R"	6	
VENTOSAS FUNDICIÓN DÚCTIL BRIDA Y ROSCADA	15	
VENTOSAS POLIAMIDA	14	
VENTOSAS ARI	14	
VOLANTE Y CAPUCHÓN PARA VÁLVULA COMPUERTA Y REGISTRO	3	

VÁLVULA DE COMPUERTA CIERRE ELÁSTICO "MODELO GA" PN-10/16

**FUNDICIÓN GRIS
CON VOLANTE
BRIDA PN-10**

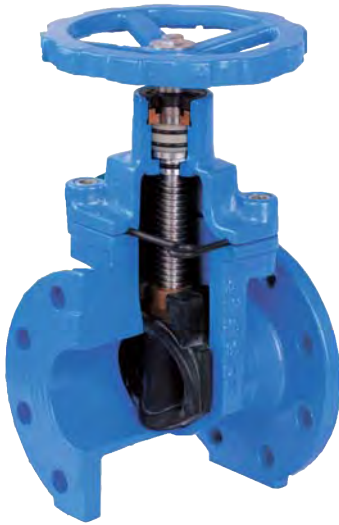

**FUNDICIÓN DÚCTIL
CON VOLANTE
BRIDA PN-10**

REFERENCIA	PASO	EUROS	REFERENCIA	PASO	EUROS
VC018050	50	85,00	VC017040	40	84,00
VC018065	65	111,00	VC017050	50	88,00
VC018080	80	130,00	VC017060	65	117,00
VC018100	100	174,00	VC017080	80	136,00
VC018125	125	232,00	VC017100	100	178,00
VC018150	150	267,00	VC017125	125	252,00
VC018200	200	392,00	VC017150	150	287,00
VC018250	250	669,00	VC017200	200	426,00
VC018300	300	1.139,00	VC017250	250	714,00
VC018400	400	2.710,00	VC017300	300	1.324,00
			VC017350	350	2.072,00
			VC017400	400	2.807,00

**FUNDICIÓN GRIS
CON VOLANTE
BRIDA PN-16**

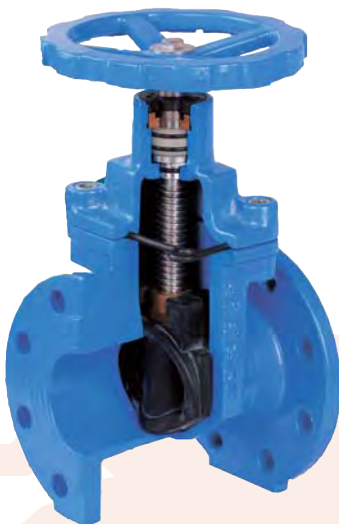

**FUNDICIÓN DÚCTIL
CON VOLANTE
BRIDA PN-16**

REFERENCIA	PASO	EUROS	REFERENCIA	PASO	EUROS
VC019200	200	392,00	VC020200	200	426,00
VC019250	250	669,00	VC020250	250	714,00
VC019300	300	1.139,00	VC020300	300	1.324,00
VC019400	400	2.710,00	VC020350	350	2.072,00
			VC020400	400	2.807,00
			VC020450	450	3.485,00
			VC020500	500	4.910,00
			VC020600	600	9.530,00

VÁLVULA DE COMPUERTA CIERRE ELÁSTICO ENCHUFE PARA PVC CON VOLANTE "MODELO GA" PN-10/16



REFERENCIA	MEDIDA	EUROS
VC021063	63	91,00
VC021075	75	117,00
VC021080	90	143,00
VC021100	110	189,00
VC021125	125	292,00
VC0210150	160	297,00
VC021200	200	445,00
VC0210250	250	739,00
VC021300	300	1.362,00

VÁLVULA COMPUERTA CIERRE ELÁSTICO TIPO CUELLO FUND. DÚCTIL CON VOLANTE



REFERENCIA	MEDIDA	EUROS
VC011050	50	189,00
VC011060	60	216,00
VC011080	80	268,00
VC011100	100	327,00
VC011125	125	420,00
VC011150	150	508,00
VC011200	200	836,00
VC011250	250	1.355,00
VC011300	300	1.787,00

VÁLVULA COMPUERTA CIERRE ELÁSTICO "MOD. GA" TIPO BRIDA FUND. GGG-50 PN-25 CON VOLANTE



REFERENCIA	MEDIDA	EUROS
VC013050	50	128,00
VC013065	65	163,00
VC013080	80	195,00
VC013100	100	254,00
VC013125	125	344,00
VC013150	150	432,00
VC013200	200	678,00
VC013250	250	1.092,00
VC013300	300	2.018,00

VÁLVULA DE COMPUERTA CIERRE METAL EMBRIDADA



REFERENCIA	PASO	EUROS	REFERENCIA	PASO	EUROS
VC810050	50	130,00	VC810200	200	545,00
VC810060	60	144,00	VC810250	250	792,00
VC810070	70	168,00	VC810300	300	1.175,00
VC810080	80	187,00	VC810400	400	2.072,00
VC810100	100	230,00			
VC810125	125	308,00			
VC810150	150	372,00			

VÁLVULA DE REGISTRO ROSCA HEMBRA "MODELO GA"



REFERENCIA	MEDIDA	ESP	EUROS
VC015025	25	3/4"	75,00
VC015125	25	1"	77,00
VC015032	32	1 1/4"	87,00
VC015040	40	1 1/2"	107,00
VC015050	50	2"	121,00

VOLANTE VÁLVULA COMPUERTA

“MODELO GA”



REFERENCIA	MEDIDA	EUROS	REFERENCIA	MEDIDA	EUROS
VC014030	25-50	11,42	VC012500	25-40-50-65	6,52
VC014040	40-50	17,94	VC016580	80-100	7,30
VC014065	65	21,21	VC100150	125-150-200	14,68
VC014080	80	21,21	VC250300	250-300	14,68
VC014100	100	21,21	VC000400	400	17,94
VC014125	125-150	45,68			
VC014200	200	65,26			
VC014250	250-300	94,63			
VC014400	400	223,54			

TRAMPILLON

“MODELO GA”



REFERENCIA	MEDIDA	EUROS
TRA19X19	14X14	39,00
TRA16X16	19X19	62,00

TRAMPILLON “VARIOS MODELOS”



MOD. MURCIA

REFERENCIA	DESCRIPCIÓN	EUROS
TRAMPSEV	MOD. SEVILLA	69,00
TRAMPBAR	MOD. BARCELONA	20,00
TRAM125	MOD. MURCIA	60,29
TRAMALM	MOD. ALMERIA	45,69



MOD. ALMERIA



MOD. BARCELONA



MOD. SEVILLA

PROLONGADOR TELESCÓPICO PARA VÁLVULA DE COMPUERTA C/ELÁSTICO

“MODELO GA”



REFERENCIA	LONGITUD	EUROS
PT10501750	1050-1750	150,00
PT6501100	650-1100	123,00

VÁLVULAS DE MARIPOSA TIPO WAFER PN-10/16 VAMEIN



ACCIONAMIENTO PALANCA

ACCIONAMIENTO REDUCTOR

REFERENCIA	MEDIDA	EUROS	REFERENCIA	MEDIDA	EUROS
VM010050	50	63,00	VM020050	50	176,00
VM010065	65	67,00	VM020065	65	180,00
VM010080	80	73,00	VM020080	80	186,00
VM010100	100	83,00	VM020100	100	195,00
VM010125	125	97,00	VM020125	125	210,00
VM010150	150	117,00	VM020150	150	230,00
VM010200	200	168,00	VM020200	200	281,00
VM010250	250	358,00	VM020250	250	442,00
VM010300	300	480,00	VM020300	300	563,00
			VM020350	350	1.224,00
			VM020400	400	1.568,00
			VM020450	450	2.262,00
			VM020500	500	2.759,00
			VM020600	600	4.880,00
			VM020700	700	6.560,00
			VM020750	750	7.480,00
			VM020800	800	8.402,00
			VM020900	900	11.550,00
			VM021100	1000	14.200,00



VÁLVULA DE MARIPOSA TIPO WAFER PN-10/16 MARIPOSA EN ACERO INOXIDABLE VAMEIN

ACCIONAMIENTO PALANCA

ACCIONAMIENTO REDUCTOR

REFERENCIA	MEDIDA	EUROS	REFERENCIA	MEDIDA	EUROS
VMI010050	50	93,00	VMI020050	50	215,00
VMI010065	65	101,00	VMI020065	65	223,00
VMI010080	80	112,00	VMI020080	80	233,00
VMI010100	100	135,00	VMI020100	100	256,00
VMI010125	125	165,00	VMI020125	125	287,00
VMI010150	150	211,00	VMI020150	150	331,00
VMI010200	200	314,00	VMI020200	200	435,00
VMI010250	250	655,00	VMI020250	250	696,00
VMI010300	300	924,00	VMI020300	300	946,00
			VMI020350	350	1.654,00
			VMI020400	400	2.125,00
			VMI020450	450	3.342,00
			VMI020500	500	3.836,00
			VMI020600	600	7.225,00

VÁLVULA DE GUILLOTINA TIPO WAFER

CUERPO: HF GG25 - TAJADERA: AISI-304

CIERRE EPDM - EMPAQUET: SINT+PTFE



REFERENCIA	MEDIDA	EUROS
VG000050	50	176,00
VG000065	65	190,00
VG000080	80	201,00
VG000100	100	227,00
VG000125	125	270,00
VG000150	150	315,00
VG000200	200	451,00
VG000250	250	582,00
VG000300	300	718,00
VG000350	350	1.275,00
VG000400	400	1.550,00
VG000450	450	1.915,00
VG000500	500	2.348,00
VG000600	600	3.220,00

VÁLVULA DE PUENTE



REFERENCIA	MEDIDA	EUROS
VP393003	100	225,00
VP393004	150	294,00
VP393005	200	349,00
VP393006	250	458,00
VP393007	300	574,00

VÁLVULA DE RETENCIÓN DOBLE DISCO INOX. PN-10/16

“MODELO GA”



REFERENCIA	MEDIDA	EUROS
VR891000	50	35,00
VR891001	65	41,00
VR891002	80	51,00
VR891003	100	59,00
VR891004	125	85,00
VR891005	150	115,00
VR891006	200	185,00
VR891007	250	281,00
VR891008	300	370,00
VR8910	350	652,00
VR891110	400	832,00
VR891111	500	1.615,00
VR891112	600	2.252,00

VÁLVULA RETENCIÓN DOBLE DISCO PN-25 "MODELO GA"



REFERENCIA	MEDIDA	EUROS	REFERENCIA	MEDIDA	EUROS
VR890100	50	99,00	VR890106	200	335,00
VR890101	65	102,00	VR890107	250	552,00
VR890102	80	120,00	VR890108	300	682,00
VR890103	100	145,00	VR890109	350	1.172,00
VR890104	125	190,00	VR890110	400	1.490,00
VR890105	150	224,00			

VÁLVULA RETENCIÓN UNICHECK "MOD. GA" TIPO CHECK - SIMPLE CLAPETA - CUERPO FUNDICIÓN - DISCO INOX



REFERENCIA	MEDIDA	EUROS	REFERENCIA	MEDIDA	EUROS
VR891022	50	48,00	VR891029	250	320,00
VR891023	65	54,00	VR891030	300	418,00
VR891024	80	60,00	VR891031	350	
VR891025	100	77,00	VR891032	400	CONSULTAR PRECIOS
VR891026	125	112,00	VR891033	500	
VR891027	150	128,00	VR891034	600	
VR891028	200	184,00			

VÁLVULA RETENCIÓN SERIE "R" CUERPO Y DISCO INOX CF8M - PRESIÓN MÁXIMA TRABAJO PN-10



REFERENCIA	MEDIDA	EUROS	REFERENCIA	MEDIDA	EUROS
VR891121	40	270,00	VR891129	250	882,00
VR891122	50	270,00	VR891130	300	1.142,00
VR891123	65	270,00	VR891131	350	1.684,00
VR891124	80	315,00	VR891132	400	2.086,00
VR891125	100	350,00	VR891133	450	2.512,00
VR891126	125	494,00	VR891134	500	2.916,00
VR891127	150	552,00	VR891135	600	3.895,00
VR891128	200	663,00			

VÁLVULA DE RETENCIÓN DE BOLA AGUAS RESIDUALES, LÍQUIDOS CARGADOS, ESPESOS Y VISCOSOS "MODELO GA"



REFERENCIA	MEDIDA	TIPO	EUROS
VR890014	50	BRIDA PN-10/16	92,00
VR890015	65	BRIDA PN-10/16	143,00
VR890016	80	BRIDA PN-10/16	149,00
VR890017	100	BRIDA PN-10/16	230,00
VR890018	125	BRIDA PN-10/16	447,00
VR890019	150	BRIDA PN-10/16	514,00
VR890020	200	BRIDA PN-10	936,00
VR890120	200	BRIDA PN-16	936,00
VR890021	250	BRIDA PN-10	CONSULTAR
VR890022	300	BRIDA PN-10	CONSULTAR

VÁLVULA DE RETENCIÓN DE BOLA ROSCADA



REFERENCIA	MEDIDA	EUROS	REFERENCIA	MEDIDA	EUROS
VR890114	1"	39,00	VR890117	2"	70,00
VR890115	1 1/4"	44,00	VR890118	2 1/2"	97,00
VR890116	1 1/2"	59,00	VR890119	3"	147,00

VÁLVULA DE RETENCIÓN CON BRIDAS CLAPETA OSCILANTE (cierre de neopreno)



REFERENCIA	MEDIDA	EUROS
VR890025	50	111,00
VR890125	65	130,00
VR890026	80	148,00
VR890027	100	179,00
VR890028	125	262,00
VR890029	150	362,00
VR890030	200	587,00
VR890031	250	865,00
VR890032	300	1.310,00
VR890033	350	1.520,00
VR890034	400	2.480,00

VÁLVULA DE PIE EN FUNDICIÓN FILTRO ACERO INOXIDABLE



REFERENCIA	MEDIDA	EUROS
VP392002	80	258
VP392003	100	304
VP392004	125	396
VP392005	150	467
VP392006	200	668
VP392007	250	869
VP392008	300	2.288,00

JUNTA BRIDA PLANA

NEOPRENO ADHESIVA

NEOPRENO TALADRADA

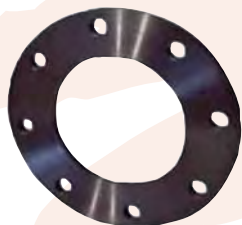
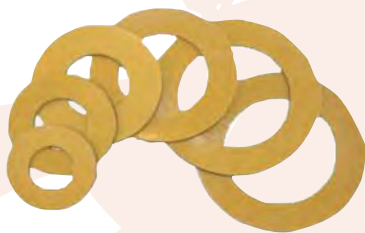

REFERENCIA	MEDIDA	EUROS	REFERENCIA	MEDIDA	EUROS
JN059025	25	0,28	JN060050	50	1,10
JN059032	32	0,34	JN060060	65	1,43
JN059040	40	0,43	JN060080	80	1,89
JN059050	50	0,55	JN060100	100	2,34
JN059060	60	0,70	JN060125	125	3,15
JN059080	80	0,74	JN060150	150	3,94
JN059100	100	0,95	JN060200	200	5,35
JN059125	125	1,43	JN060250	250	8,99
JN059150	150	1,68	JN060300	300	9,79
JN059200	200	2,69	JN060350	350	15,08
JN059250	250	4,28	JN060400	400	21,20
JN059300	300	6,57	JN060450	450	23,47
JN059350	350	10,03	JN060500	500	34,51
JN059400	400	10,37	JN060600	600	45,53
JN059450	450	12,94			
JN059500	500	16,12			
JN059600	600	21,90			



BOCA DE RIEGO RECTANGULAR TIPO MADRID TOMA ROSCA 1 1/2"

REFERENCIA	DENOMINACIÓN	EUROS
BR392013	ROSCA 40 TALAVERA, GAS, SEGOVIA, ZARAGOZA, ETC.	143,00
BR392214	ROSCA MADRID	124,00
BR392014	ENLACE RAP. 45	100,00
BR392015	ENLACE RAP. 70	113,00



BOCA DE RIEGO RECTANGULAR TIPO MADRID CON CERRADURA Y LLAVE TOMA ROSCA 1 1/2"

REFERENCIA	DENOMINACIÓN	EUROS
BR392113	ROSCA 40 TALAVERA, GAS, SEGOVIA, ZARAGOZA, ETC.	151,00
BR392213	ROSCA MADRID	133,00
BR392114	ENLACE RAP. 45	108,00
BR392115	ENLACE RAP. 70	118,00



BOCA DE RIEGO OVALADA TIPO BARCELONA

REFERENCIA	DENOMINACIÓN	EUROS
BR392313	ROSCA 40 TALAVERA, SEGOVIA, GRANADA, GAS, ETC.	131,00
BR392017	ENLACE RAP. 45	88,00



BOCA DE RIEGO TIPO ZARAGOZA

REFERENCIA	DENOMINACIÓN	EUROS
BR392011	ENLACE RAP. 45	121,00
BR392016	ENLACE ROSCA 40	129,00
BR392020	ENLACE ROSC. T. PALENCIA	146,00



TAPA PARA BOCA DE RIEGO TIPO ZARAGOZA

REFERENCIA	DENOMINACIÓN	EUROS
TRAMPZAR	TIPO ZARAGOZA	39,00



TUERCA DE TRANSICIÓN

REFERENCIA	DENOMINACIÓN	EUROS
AL000010	TUERCA ADAPTADOR LATÓN 1" 1/4 ROSCA TALAVERA, GRANADA, BURGOS ZARAGOZA, ALMERIA Y SORIA	58,00
AL000011	TUERCA ADAPTADOR LATÓN 1" 1/4 ROSCA HUESCA, SEGOVIA, SANTANDER	68,00



BOCA DE RIEGO TIPO SANTANDER

REFERENCIA	DENOMINACIÓN	EUROS
BR392025	SALIDA ROSCA 40 ROSCA SANTANDER, OVIEDO, BILBAO, ETC...	144,00
BR392026	SALIDA ENLACE RAPIDO 45	155,00



TAPA BOCA DE RIEGO TIPO SANTANDER

REFERENCIA	DENOMINACIÓN	EUROS
TRAMSAN	TIPO SANTANDER	43,00

BOCA DE RIEGO RECTANGULAR CON CERRADURA Y LLAVE TOMA BRIDA F. DÚCTIL GGG -50



REFERENCIA	MEDIDA	EUROS
BR392024	40 x 1 1/2"	165,00
*SALIDA E. RÁPIDO DE 45 *BAJO PEDIDO SALIDA ROSCADA		

BOCA DE RIEGO TIPO GRANADA



REFERENCIA	DENOMINACIÓN	EUROS
BR392018	BOCA TIPO GRANADA	211,00
BR392023	TAPA BOCA RIEGO	32,00

CONTADOR CHORRO MULTIPLE CONEXIÓN ROSCADA



REFERENCIA	MEDIDA	EUROS
CONT00015	15 - 1/2"	57,00
CONT00020	20 - 3/4"	63,00
CONT00032	25 - 1"	99,00
CONT00040	32 - 11/4"	111,00
CONT00050	40 - 11/2"	188,00
CONT00063	50 - 2"	279,00
EMISOR 1	EMISOR DE IMPULSOS	51,00

CONTADOR TIPO WOLTMAN EMBRIDADO



REFERENCIA	MEDIDA	EUROS
CONT00150	50	295,00
CONT00065	65	320,00
CONT00080	80	357,00
CONT00100	100	382,00
CONT00125	125	497,00
CONT00250	150	688,00
CONT00200	200	910,00
EMISOR 2	EMISOR DE IMPULSOS	90,00

UNIÓN UNIVERSAL PN-16 "MODELO GA"



REFERENCIA	MEDIDA	RANGO	EUROS
UV057074	50	57-74	37,00
UV068085	65	68-85	46,00
UV084106	80	84-106	59,00
UV099119	80	99-119	63,00
UV109133	100	109-133	72,00
UV132157	125	132-157	98,00
UV157183	150	157-183	100,00
UV176201	150	176-201	112,00
UV193215	175	193-215	123,00
UV218242	200	218-242	142,00
UV242268	225	242-268	179,00
UV266292	250	266-292	200,00
UV280306	250	280-306	210,00
UV301327	300	301-327	213,00
UV384410	350	384-410	354,00

UNIÓN MULTI-MEDIDA "MOD. GA"



REFERENCIA	MEDIDA	EUROS	REFERENCIA	MEDIDA	EUROS
UM060095	61-94	103,00	UM395435	396-434	503,00
UM080115	81-114	127,00	UM435470	436-469	570,00
UM105135	106-134	138,00	UM470505	471-504	627,00
UM130165	131-164	174,00	UM505540	506-539	820,00
UM155195	156-194	197,00	UM540575	541-574	845,00
UM190230	191-229	221,00	UM575610	574-609	910,00
UM215258	216-257	262,00	UM610645	609-644	932,00
UM240280	241-279	295,00	UM645680	646-679	1.102,00
UM235275	236-274	304,00	UM680715	681-714	1.160,00
UM270310	271-309	307,00	UM710745	711-744	1.362,00
UM310350	311-351	352,00	UM810845	811-844	1.573,00
UM350390	349-389	366,00			

UNIÓN MULTI-MEDIDA GRAN TOLERANCIA "MOD. GA"



REFERENCIA	MEDIDA	EUROS
UMGT156191	156-194 / 191-229	264,00
UMGT191216	191-229 / 216-257	327,00
UMGT216271	216-257 / 271-309	360,00
UMGT311351	311-349 / 351-389	446,00
UMGT351396	351-389 / 396-434	599,00
UMGT396436	396-434 / 436-469	608,00
UMGT396471	396-434 / 471-504	625,00
UMGT396506	396-434 / 506-539	736,00
UMGT471506	471-504 / 506-539	728,00
UMGT471541	471-504 / 541-574	789,00
UMGT506541	506-539 / 541-574	851,00
UMGT579611	579-609 / 611-644	942,00

BRIDA UNIVERSAL PN-16 "MODELO GA"



REFERENCIA	MEDIDA	RANGO	EUROS	REFERENCIA	MEDIDA	RANGO	EUROS
BU 057074	50	57-74	41,00	BU 193215	200	193-215	116,00
BU 068085	65	68-85	48,00	BU 218242	200	218-242	143,00
BU 084106	80	84-106	56,00	BU 242268	250	242-268	170,00
BU 099119	100	99-119	60,00	BU 266292	250	266-292	182,00
BU 109133	100	109-133	75,00	BU 280306	250	280-306	212,00
BU 132157	125	132-157	86,00	BU 301327	300	301-327	223,00
BU 157183	150	157-183	95,00	BU 384410	400	384-410	430,00

BRIDA MULTI-MEDIDA "MOD. GA"



REFERENCIA	DN	MEDIDA	EUROS
BM311349	300	311-349	446,00
BM351389	300	351-389	475,00
BM350390	350	351-389	520,00
BM396434	400	396-434	602,00
BM436469	400	436-469	655,00
BM471507	500	471-507	798,00
BM506539	500	506-539	854,00
BM541574	500	541-574	997,00
BM611644	600	611-644	1095,00



TAPÓN UNIVERSAL "MOD. GA"

REFERENCIA	MEDIDA	EUROS	REFERENCIA	MEDIDA	EUROS
TU084106	84-106	52,02	TU157183	157-183	95,56
TU109133	109-133	58,35	TU193215	193-215	107,31
TU132157	132-157	79,59	TU218242	218-242	119,70



DISPONIBLE CON TORNILLO
ACERO INOX
CONSULTAR PRECIO

UNIÓN ANTITRACCIÓN PARA PVC Y P.E. "MODELO GA"

REFERENCIA	MEDIDA	EUROS	REFERENCIA	MEDIDA	EUROS
UA000050	50	62,00	UA000140	140	161,00
UA000063	63	65,00	UA000160	160	177,00
UA000075	75	73,00	UA000200	200	245,00
UA000090	90	84,00	UA000250	250	498,00
UA000110	110	108,00	UA000315	315	700,00
UA000125	125	146,00			

UNIÓN ANTITRACCIÓN "MODELO FS GRIP"



REFERENCIA	MEDIDA	EUROS	REFERENCIA	MEDIDA	EUROS
UA000350	345-360	1.144,00	UA000700	705-720	1.666,00
UA000400	395-410	1.177,00	UA000800	795-810	1.925,00
UA000450	445-460	1.476,00	UA000900	895-910	2.114,00
UA000500	495-510	1.539,00	UA001000	995-1010	2.307,00
UA000600	625-640	1.606,00			

BRIDA ANTI-TRACCIÓN PARA PVC Y P.E. "MODELO GA"



DISPONIBLE CON TORNILLO
ACERO INOX
CONSULTAR PRECIO

REFERENCIA	MEDIDA	EUROS	REFERENCIA	MEDIDA	EUROS
BA000063	50/63	63,00	BA000160	150/160	146,00
BA000075	65/75	69,00	BA000200	200/200 PN10	207,00
BA000090	80/90	76,00	BA001200	200/200 PN16	207,00
BA000110	100/110	90,00	BA000250	250	403,00
BA000125	125/125	127,00	BA000315	315	490,00
BA000140	125/140	129,00	BA000400	400/400 PN 16	620,00

BRIDA ANTI-TRACCIÓN MODELO FS GRIP



REFERENCIA	MEDIDA	EUROS	REFERENCIA	MEDIDA	EUROS
BA000450	450	2.154,00	BA000800	800	3.950,00
BA000500	500	2.297,00	BA000900	900	5.107,00
BA000600	600/630	2.543,00	BA001000	1000	5.876,00
BA000700	700/710	3.312,00			

BRIDA DOBLE CAMARA "MODELO GA" FUNDICIÓN DÚCTIL GGG-50 AUTOBLOCANTE PARA TUBO DE PVC Y P.E.



REFERENCIA	DN	TUBERIA	EUROS
BDA60063	50	63	30,00
BDA60075	65	75	33,00
BDA60090	80	90	39,00
BDA60110	100	110	47,00
BDA60125	125	125	59,00
BDA60140	125	140	64,00
BDA60160	150	160	88,00
BDA60200	200	200	167,00
BDA60250	250	250	277,00
BDA60315	300	315	320,00

UNIÓN DE TRANSICIÓN AUTOBLOCANTE / UNIVERSAL "MODELO GA"



REFERENCIA	MEDIDA	EUROS	REFERENCIA	MEDIDA	EUROS
UT057074063	57-74/63	144,00	UT109133125	109-133/125	248,00
UT068085075	68-85/75	150,00	UT132157125	132-157/125	269,00
UT084106090	84-106/90	173,00	UT132157140	132-157/140	280,00
UT099119090	99-119/90	205,00	UT157183160	157-183/160	312,00
UT099119110	99-119/110	218,00	UT193215200	193-215/200	406,00
UT109133110	109-133/110	227,00	UT218242200	218-242/200	430,00

COLLARÍN REPARACIÓN ANTI-TRACCIÓN "MOD. GA"



REFERENCIA	MEDIDA	EUROS	REFERENCIA	MEDIDA	EUROS
CR000063	63	112,00	CR000140	140	214,00
CR000075	75	118,00	CR000160	160	292,00
CR000090	90	125,00	CR000200	200	404,00
CR000110	110	147,00	CR000250	250	480,00
CR000125	125	194,00			

MANGUITO ELÁSTICO ROSCADO DOBLE ONDA

“MODELO GA”



REFERENCIA	MEDIDA	EUROS
ME392039	1/2"	12,00
ME392040	3/4"	16,00
ME392041	1"	18,00
ME392042	1 1/4"	23,00
ME392043	1 1/2"	28,00
ME392044	2"	34,00
ME392045	2 1/2"	44,00
ME392046	3"	57,00

MANGUITOS ELÁSTICOS SIMPLE ONDA-TIPO FSF (BRIDAS PN-10)

“MODELO GA”

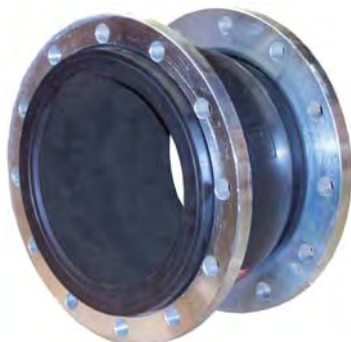

REFERENCIA	MEDIDA	EUROS
ME392025	50	30,00
ME392026	65	39,00
ME392027	80	48,00
ME392028	100	60,00
ME392029	125	90,00
ME392030	150	108,00
ME392031	200	180,00
ME392032	250	264,00
ME392033	300	319,00
ME392034	350	402,00
ME392035	400	459,00
ME392036	450	517,00
ME392037	500	646,00
ME392038	600	882,00

MANGUITOS ELÁSTICOS SIMPLE ONDA-TIPO FSF (BRIDAS PN-16)

“MODELO GA”



REFERENCIA	MEDIDA	EUROS
ME392131	200	180,00
ME392132	250	290,00
ME392133	300	351,00
ME392134	350	442,00
ME392135	400	505,00
ME392136	450	568,00
ME392137	500	712,00
ME392138	600	969,00



VENTOSA ARI-BARAK TRIFUNCIONAL



REFERENCIA	MEDIDA	EUROS
VB392039	BASE BRONCE 1"	105,00
VB392040	BASE BRONCE 2"	255,00
VB392041	BASE PLÁSTICO 1"	82,00
VB392042	BASE PLÁSTICO 2"	190,00



VENTOSA SIMPLE EFECTO-CINETICAS

REFERENCIA	MODELO	DESCRIPCION	CANTIDAD POR CAJA	EUROS
VB392043	ARV-1"-K	1"M, Poliamida + Fibra Vidrio	14	13,00
VB392044	ARV-2"-K	2"M, Poliamida + Fibra Vidrio	8	22,00



DOBLE EFECTO CINÉTICAS Y AUTOMÁTICAS

REFERENCIA	MODELO	DESCRIPCION	CANTIDAD POR CAJA	EUROS
VB392045	ARV-1"-A	1"M, Poliamida + Fibra Vidrio	20	24,00
VB392046	ARV-1"-A	2"M, Poliamida + Fibra Vidrio	8	62,00

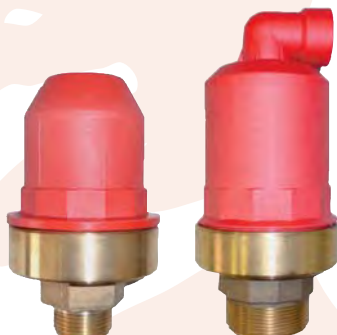

DOBLE EFECTO CINÉTICAS Y AUTOMÁTICAS

REFERENCIA	MODELO	DESCRIPCION	CANTIDAD POR CAJA	EUROS
VB392145	ARV-1"-A	1"M, Poliamida + Latón	20	42,00
VB392146	ARV-1"-A	2"M, Poliamida + Latón	8	93,00



VENTOSA AUTOMÁTICA FUNDICIÓN DÚCTIL

REFERENCIA	D.N	DOBLE EFECTO EUROS	REFERENCIA	D.N	TRIPLE EFECTO EUROS
VB392062	1"	121,00	VB392148	2"	277,00
VB392047	2"	169,00	VB392149	50	277,00
VB392048	40	121,00	VB392150	65	361,00
VB392049	50	170,00	VB392151	80	462,00
VB392050	65	250,00	VB392152	100	835,00
VB392051	80	337,00	VB392153	150	1.317,00
VB392052	100	715,00	VB392154	200	2.419,00
VB392053	150	1.091,00			
VB392054	200	2.182,00			

VENTOSA AUTOMÁTICA PASO TOTAL

PN-10/16 (RECOMENDADA PARA AGUAS RESIDUALES)



REFERENCIA	D.N	DOBLE EFECTO EUROS	REFERENCIA	D.N	TRIPLE EFECTO EUROS
VB392056	40	158,00	VB392156	40	283,00
VB392057	50	216,00	VB392157	50	342,00
VB392357	65	334,00	VB392257	65	351,00
VB392058	80	443,00	VB392158	80	576,00
VB392059	100	885,00	VB392159	100	1.018,00
VB392060	150	1.436,00	VB392160	150	1.720,00
VB392061	200	2.506,00	VB392161	200	2.756,00

VENTOSA AUTOMÁTICA PASO TOTAL

PN-25 (RECOMENDADA PARA AGUAS RESIDUALES)



REFERENCIA	D.N	DOBLE EFECTO EUROS	REFERENCIA	D.N	TRIPLE EFECTO EUROS
VB392063	40	175,00	VB392162	40	584,00
VB392064	50	242,00	VB392163	50	642,00
VB392365	65	367,00	VB392164	65	768,00
VB392066	80	488,00	VB392165	80	876,00
VB392067	100	976,00	VB392166	100	1.320,00
VB392068	150	1.587,00	VB392167	150	2.020,00
VB392069	200	2.755,00	VB392168	200	3.224,00

CARRETES DE DESMONTAJE PN-10 "MODELO GA"



REFERENCIA	MEDIDAS	EUROS
CRP10050	50	181,00
CRP10065	65	196,00
CRP10080	80	210,00
CRP10100	100	224,00
CRP10125	125	239,00
CRP10150	150	252,00
CRP10200	200	336,00
CRP10250	250	446,00
CRP10300	300	530,00
CRP10350	350	621,00
CRP10400	400	857,00
CRP10450	450	1.040,00
CRP10500	500	1.194,00
CRP10600	600	1.398,00
CRP10700	700	1.822,00
CRP10800	800	2.187,00
CRP10900	900	2.430,00
CRP11000	1000	2.916,00
CRP11100	1100	3.402,00
CRP11200	1200	3.888,00

CARRETES DE DESMONTAJE PN-16 "MODELO GA"



REFERENCIA	MEDIDAS	EUROS
CRP16080	80	210,00
CRP16200	200	370,00
CRP16250	250	464,00
CRP16300	300	554,00
CRP16350	350	652,00
CRP16400	400	939,00
CRP16450	450	1.102,00
CRP16500	500	1.362,00
CRP16600	600	1.792,00
CRP16700	700	1.944,00
CRP16800	800	2.430,00
CRP16900	900	2.673,00
CRP11016	1000	3.159,00
CRP11116	1100	3.645,00
CRP11216	1200	4.374,00

* BRIDA ACERO AL CARBONO 2576 o 2502

* VIROLA INOX 304 (OPCIONAL INOX 316 o 420)

* PINTURA AZUL EPOXI

* TORNILLERÍA INOX A2-70

FILTROS EN "Y" ROSCADO "MODELO GA"



REFERENCIA	MEDIDA	EUROS
FY393100	1/2"	11,00
FY393101	3/4"	15,00
FY393102	1"	20,00
FY393103	1 1/4"	28,00
FY393104	1 1/2"	31,00
FY393105	2"	46,00

FILTROS EN "Y" BRIDAS PN-10 "MODELO GA"



REFERENCIA	MEDIDA	EUROS
FY393109	50	59,00
FY393110	65	81,00
FY393111	80	98,00
FY393112	100	124,00
FY393113	125	198,00
FY393114	150	260,00
FY393115	200	435,00
FY393116	250	827,00
FY393117	300	1.165,00

FILTROS EN "Y" BRIDAS PN-16 "MODELO GA"

REFERENCIA	MEDIDA	EUROS
FY393215	200	435,00
FY393216	250	827,00
FY393217	300	1.165,00

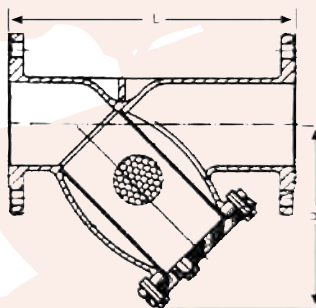

DIMENSIONES FILTRO CON BRIDAS

DN	50	65	80	100	125	150	200	250	300
L	230	290	310	350	400	480	600	730	850
H	125	150	168	213	250	281	357	460	532
KG	8,5	11	15	19	28	38	65	96	145

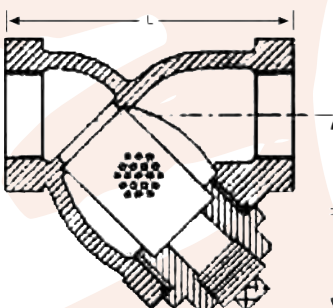

DIMENSIONES FILTRO CON ROSCA

DN	20	25	32	40	50
L	98	116	135	154	190
H	72	87	100	115	145
KG	1,2	1,8	2,3	3,6	6,5

UNIONES GUIBAULT PARA TUBERÍA DE PVC Y POLIETILENO SERIE LARGA "MODELO GA"



REFERENCIA	MEDIDA	ANCHO	EUROS
UP440050	50	130	8,10
UP440063	63	130	9,70
UP440075	75	130	11,30
UP440090	90	140	13,58
UP440110	110	150	18,89
UP440125	125	150	21,80
UP440140	140	150	24,00
UP440160	160	180	29,56
UP440180	180	180	38,45
UP440200	200	185	54,25
UP440250	250	210	73,15
UP440315	315	215	95,29
UP440400	400	210	123,68
UP440500	500	210	163,86

ARO LATERAL UNIÓN GUIBAULT PVC CON GOMA "MODELO GA"



REFERENCIA	MEDIDA	EUROS
AL450063	63	2,34
AL450075	75	3,40
AL450090	90	4,32
AL450110	110	4,53
AL450125	125	4,88
AL450140	140	6,85
AL450160	160	7,62
AL450180	180	10,05
AL450200	200	11,76
AL450250	250	18,78
AL450315	315	27,96
AL450400	400	34,14
AL450500	500	56,72

UNIÓN GUIBAULT PARA PVC CUERPO FUND. DÚCTIL, PINTURA EPOXI "MOD. GA"



REFERENCIA	MEDIDA	ANCHO	EUROS
UP441050	50	120	17,56
UP441063	63	143	21,20
UP441075	75	147	25,22
UP441090	90	145	30,70
UP441110	110	165	36,65
UP441125	125	165	40,72
UP441140	140	168	53,52
UP441160	160	202	63,55
UP441200	200	204	87,18
UP441250	250	227	123,47
UP441315	315	230	157,71
UP441400	400	230	260,10

UNIÓN GUIBAULT CON CARRETE PVC "MODELO GA"



REFERENCIA	MEDIDA	LARGO	EUROS
UP450063	63		13,54
UP450075	75		17,28
UP450090	90		20,04
UP450110	110		24,68
UP450125	125		36,52
UP450140	140		46,40
UP450160	160		54,89
UP450200	200		74,80
UP450250	250		202,63
UP450315	315		289,50

UNION GIBALT PARA TUBERÍA DE FIBROCEMENTO "MODELO GA"



REFERENCIA	TIPO	MEDIDA	INTERIOR	EUROS
UF050050	A/F	50	66	10,62
UF050060	A/F	60	76	13,22
UF050070	A/F	70	86	17,68
UF050080	A/D	80	98	19,15
UF050180	E/F	80	102	19,95
UF050100	A/D	100	119	21,85
UF051100	E/F	100	124-126	24,11
UF050125	A/C	125	143	27,15
UF050150	A/C	150	174	34,85
UF050200	A/B	200	224-227	49,78
UF050250	A	250	274-272	59,61
UF051250	B	250	280	61,96
UF050300	A	300	324	90,50
UF051300	B	300	334	95,02

* PARA OTRAS MEDIDAS CONSULTAR

BRIDA DOBLE CAMARA FUNDICIÓN GRIS GG-25 PARA TUBO DE PVC "MODELO GA"

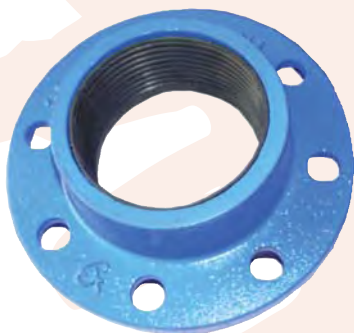

REFERENCIA	MEDIDA	EUROS
BD460063	63	17,00
BD460075	75	19,00
BD460090	90	26,00
BD460110	110	29,00
BD460125	125	36,00
BD460140	140	38,00
BD460160	160	49,00
BD460200	200	84,00
BD460250	250	125,00
BD460315	315	156,00

* CON GOMAS Y SIN TORNILLOS

GOMA UG. DE FIBROCEMENTO



REFERENCIA	MEDIDA	EUROS	REFERENCIA	MEDIDA	EUROS
GO100050	50	0,40	GO100200	200	2,50
GO100060	60	0,52	GO100250	250	3,09
GO100070	70	0,82	GO100300	300	3,40
GO100080	80	0,95	GO100350	350	5,97
GO100100	100	1,07	GO100400	400	6,78
GO100125	125	1,43	GO100450	450	7,29
GO100150	150	1,92	GO100500	500	8,15

GOMA UG. DE PVC



REFERENCIA	MEDIDA	EUROS	REFERENCIA	MEDIDA	EUROS
GO200063	63	0,62	GO200160	160	1,20
GO200075	75	0,77	GO200180	180	1,40
GO200090	90	0,92	GO200200	200	1,87
GO200110	110	1,00	GO200250	250	2,39
GO200125	125	1,05	GO200315	315	3,95
GO200140	140	1,12	GO200400	400	7,28

GOMA DE BRIDA DE DOBLE CÁMARA



REFERENCIA	MEDIDA	EUROS	REFERENCIA	MEDIDA	EUROS
GO300063	63	3,06	GO300140	140	6,51
GO300075	75	3,42	GO300160	160	7,38
GO300090	90	3,85	GO300180	180	18,60
GO300110	110	4,89	GO300200	200	20,68
GO300125	125	6,12	GO300250	250	25,67
			GO300315	315	69,00

ABRAZADERA DE REPARACIÓN 1 CIERRE "MODELO GA"



- * CUERPO DE ACERO
INOX AISI-304
- * JUNTA DE EPDM
- * TORNILLOS Y TUERCAS
DE ACERO INOX
- * 1 CIERRE

MM RANGO	LARGO	EUROS
48-52	150	68,00
54-58	150	69,00
60-67	150	71,00
67-74	150	75,00
70-77	150	78,00
73-80	150	77,00
76-83	150	76,00
82-89	150	79,00
87-94	150	80,00
91-98	150	81,00
95-102	150	83,00
98-108	150	84,00
102-112	150	85,00
106-116	150	85,00
108-118	150	86,00
113-123	150	86,00
118-128	150	88,00
120-131	150	87,00
125-135	150	89,00
132-142	150	92,00
135-145	150	95,00
145-155	150	96,00
151-161	150	100,00

ABRAZADERA DE REPARACIÓN 2 CIERRES "MODELO GA"



- * CUERPO DE ACERO
INOX AISI-304
- * JUNTA DE EPDM
- * TORNILLOS Y TUERCAS
DE ACERO INOX
- * 2 CIERRES

MM RANGO	LARGO	EUROS	MM RANGO	LARGO	EUROS
140-160	200	172,00	273-293	200	228,00
159-180	200	175,00	282-302	200	230,00
165-185	200	178,00	295-315	200	233,00
168-189	200	180,00	299-330	200	234,00
170-190	200	181,00	315-335	200	234,00
176-196	200	182,00	322-344	200	237,00
190-210	200	189,00	337-358	200	239,00
195-217	200	194,00	347-367	200	242,00
210-230	200	196,00	365-385	200	245,00
216-238	200	209,00	382-402	200	258,00
225-246	200	216,00	396-420	200	260,00
230-250	200	220,00	410-430	200	262,00
240-260	200	222,00	420-440	200	263,00
250-270	200	224,00	435-455	200	265,00
269-289	200	227,00			

UNIONES ARPOL CUERPO Y TORNILLERIA EN ACERO INOX AISI-304 ARPOL FIX-U PARA P.E.A.D.



REFERENCIA	MEDIDA	BARES	EUROS
ARFIX-U63	63	16	142,00
ARFIX-U75	75	16	159,00
ARFIX-U90	90	16	171,00
ARFIX-U110	110	16	187,00
ARFIX-U125	125	16	216,00
ARFIX-U140	140	16	254,00
ARFIX-U160	160	16	272,00
ARFIX-U180	180	16	484,00
ARFIX-U200	200	16	524,00
ARFIX-U250	250	16	591,00
ARFIX-U315	315	10	710,00
ARFIX-U400	400	10	920,00

UNIONES ARPOL CUERPO Y TORNILLERIA EN ACERO INOX AISI-304 ANCHO DE UNIÓN 75 MM



MEDIDA	BARES	EUROS
47-49	45	122,00
53-55	45	122,00
56-58	40	122,00
60-64	40	122,00

UNIONES ARPOL CUERPO Y TORNILLERIA EN ACERO INOX AISI-304 ANCHO DE UNIÓN 90 MM

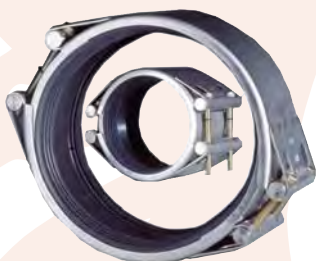

MEDIDA	BARES	EUROS
74-78	30	122,00
80-86	30	124,00
87-93	30	125,00
98-106	30	129,00
107-111	30	130,00
110-116	30	133,00
118-125	20	136,00
125-131	20	136,00
131-136	20	137,00
137-144	20	139,00
147-156	20	142,00
156-162	20	144,00

* CONSULTAR PARA OTRAS MEDIDAS Y PRESIONES

UNIONES ARPOL CUERPO Y TORNILLERIA EN ACERO INOX AISI-304 ANCHO DE UNIÓN 140 MM



MEDIDA	BARES	EUROS
166-178	23	209,00
173-185	23	209,00
186-198	23	209,00
194-206	23	209,00
202-214	18	228,00
217-229	18	228,00
231-243	18	228,00
248-260	18	228,00
271-283	15	245,00
279-291	15	245,00
292-304	15	245,00
310-322	12	264,00
320-332	12	264,00
329-341	12	264,00
338-350	12	264,00
349-361	12	264,00
359-371	11	281,00
372-384	11	281,00
379-391	11	281,00
394-406	11	281,00
403-415	13	382,00
410-422	13	382,00
419-431	13	382,00
425-437	13	382,00
433-445	13	382,00
450-462	11	403,00
467-479	11	403,00
477-489	11	403,00
487-499	11	403,00
493-505	11	403,00
504-520	13	459,00
525-541	13	459,00
539-555	13	459,00
557-573	12	484,00
583-599	12	484,00
599-615	12	484,00
614-630	13	679,00
630-346	13	679,00
650-666	8	515,00
676-692	8	515,00
706-722	11	743,00
719-735	11	743,00

* CONSULTAR PARA OTRAS MEDIDAS Y PRESIONES

UNIONES ARPOL CUERPO Y TORNILLERIA EN ACERO INOX AISI-304 ANCHO DE UNIÓN 200 MM



MEDIDA	BARES	EUROS
88-98	30	207,00
94-104	30	209,00
108-118	30	213,00
120-130	20	218,00
130-140	20	228,00
139-149	20	270,00
150-160	20	288,00
166-178	23	288,00
173-185	23	288,00
186-198	23	288,00
194-206	23	288,00
202-214	18	309,00
217-229	18	309,00
231-243	18	309,00
242-254	18	309,00
248-260	18	309,00
271-283	15	331,00
279-291	15	331,00
292-304	15	331,00
310-322	12	352,00
320-332	12	352,00
329-341	12	352,00
338-350	12	352,00
349-361	12	352,00
359-371	12	374,00
372-384	12	374,00
379-391	12	374,00
394-406	12	374,00
403-415	9	395,00
410-422	13	508,00
419-431	13	508,00
425-437	13	508,00
433-445	13	508,00
450-462	14	567,00
467-479	14	567,00
477-489	14	567,00
487-499	14	567,00
493-505	14	567,00
504-520	13	626,00
525-541	13	626,00
539-555	13	626,00
548-564	13	626,00
557-573	12	655,00
583-599	12	655,00
599-615	12	655,00
614-630	11	685,00
630-646	11	685,00

* CONSULTAR PARA OTRAS MEDIDAS Y PRESIONES

UNIONES ARPOL CUERPO Y TORNILLERIA EN ACERO INOX AISI-304 ANCHO DE UNIÓN 200 MM



MEDIDA	BARES	EUROS
650-666	11	715,00
676-692	10	715,00
706-722	9	745,00
719-735	7	745,00
734-750	9	745,00
744-760	9	745,00
757-773	10	1.086,00
767-783	10	1.086,00
788-804	10	1.086,00
808-824	10	1.128,00
820-836	10	1.128,00
837-853	10	1.128,00
851-867	9	1.166,00
866-882	9	1.166,00
877-893	9	1.166,00
900-916	9	1.210,00
908-924	9	1.210,00
921-937	9	1.210,00
938-954	8	1.210,00
957-973	8	1.250,00
976-992	8	1.250,00
987-1003	8	1.250,00
1010-1026	8	1.286,00
1042-1058	8	1.286,00
1055-1071	7	1.337,00
1078-1094	7	1.337,00
1084-1100	7	1.337,00
1097-1113	7	1.337,00
1112-1128	7	1.389,00
1124-1140	7	1.389,00
1148-1164	7	1.458,00
1172-1188	7	1.458,00
1193-1209	7	1.458,00
1208-1224	7	1.498,00

* CONSULTAR PARA OTRAS MEDIDAS Y PRESIONES

COLLARIN DE TOMA EN HIERRO FUNDIDO GG-25 PARA TUBERIA DE PVC Y POLIETILENO "MOD. GA"



REFERENCIA	TUBERIA	ROSCA	EUROS
CP220032	32	1/2"	4,13
CP221032	32	3/4"	4,13
CP222032	32	1"	4,13
CP220040	40	1/2"	4,44
CP221040	40	3/4"	4,44
CP222040	40	1"	4,44
CP220050	50	1/2"	5,88
CP221050	50	3/4"	5,88
CP222050	50	1"	5,88
CP220063	63	1/2"	6,42
CP221063	63	3/4"	6,42
CP222063	63	1"	6,42
CP223063	63	1 1/4"	6,42
CP220075	75	1/2"	6,98
CP220175	75	3/4"	6,98
CP220275	75	1"	6,98
CP220375	75	1 1/4"	7,75
CP220090	90	1/2"	7,69
CP220190	90	3/4"	7,69
CP220290	90	1"	7,69
CP220390	90	1 1/4"	8,45
CP220490	90	1 1/2"	12,27
CP220590	90	2"	12,76
CP220110	110	1/2"	10,28
CP221110	110	3/4"	10,28
CP222110	110	1"	10,28
CP223110	110	1 1/4"	11,04
CP224110	110	1 1/2"	14,65
CP225110	110	2"	14,81
CP226110	110	2 1/2"	17,16
CP220125	125	1/2"	14,17
CP221125	125	3/4"	14,17
CP222125	125	1"	14,17
CP223135	125	1 1/4"	14,93
CP224125	125	1 1/2"	17,44
CP225125	125	2"	17,96
CP226125	125	2 1/2"	19,89
CP227125	125	3"	20,22
CP220140	140	1/2"	17,84
CP221140	140	3/4"	17,84
CP222140	140	1"	17,84
CP223140	140	1 1/4"	18,6
CP224140	140	1 1/2"	19,92
CP225140	140	2"	20,71
CP226140	140	2 1/2"	21,65
CP227140	140	3"	21,98
CP220160	160	1/2"	18,73

COLLARIN DE TOMA EN HIERRO FUNDIDO GG-25 PARA TUBERIA DE PVC Y POLIETILENO "MOD. GA"



REFERENCIA	TUBERIA	ROSCA	EUROS
CP221160	160	3/4"	18,73
CP222160	160	1"	18,73
CP223160	160	1 1/4"	19,50
CP224160	160	1 1/2"	20,96
CP225160	160	2"	21,75
CP226160	160	2 1/2"	22,06
CP227160	160	3"	22,40
CP220180	180	1/2"	21,20
CP221180	180	3/4"	21,20
CP222180	180	1"	21,20
CP223180	180	1 1/4"	22,06
CP224180	180	1 1/2"	22,52
CP225180	180	2"	23,13
CP226180	180	2 1/2"	24,54
CP227180	180	3"	25,15
CP220200	200	1/2"	24,60
CP221200	200	3/4"	24,60
CP222200	200	1"	24,60
CP223200	200	1 1/4"	24,88
CP224200	200	1 1/2"	25,12
CP225200	200	2"	25,88
CP226200	200	2 1/2"	26,03
CP227200	200	3"	26,30
CP228200	200	4"	49,51
CP220250	250	1/2"	34,94
CP221250	250	3/4"	34,94
CP222250	250	1"	34,94
CP223250	250	1 1/4"	35,22
CP224250	250	1 1/2"	35,52
CP225250	250	2"	35,71
CP226250	250	2 1/2"	35,95
CP227250	250	3"	36,30
CP228250	250	4"	58,69
CP220315	315	1/2"	48,89
CP221315	315	3/4"	48,89
CP222315	315	1"	48,89
CP223315	315	1 1/4"	49,51
CP224315	315	1 1/2"	49,83
CP225315	315	2"	50,61
CP226315	315	2 1/2"	53,61
CP227315	315	3"	53,92
CP228315	315	4"	73,37
CP220400	400	2"	101,62
CP221400	400	2 1/2"	110,83
CP222400	400	3"	111,60
CP223400	400	4"	128,52

COLLARIN DE TOMA EN HIERRO FUNDIDO GG-25 PARA TUBERÍA DE FIBROCEMENTO “MODELO GA”



REFERENCIA	TUBERIA	ROSCA	EUROS
CF211050	50	1/2"	6,18
CF212050	50	3/4"	6,18
CF211060	60	1/2"	9,55
CF212060	60	3/4"	9,55
CF213060	60	1"	9,55
CF211080	80	1/2"	11,38
CF212080	80	3/4"	11,38
CF213080	80	1"	11,38
CF214080	80	1 1/4"	11,38
CF211100	100	1/2"	13,10
CF212100	100	3/4"	13,10
CF213100	100	1"	13,10
CF214100	100	1 1/4"	13,10

MANÓMETRO GLICERINA



REFERENCIA	MEDIDA	EUROS
MN10006	0-6	12,95
MN10106	0-10	12,95
MN10166	0-16	12,95

MANÓMETRO 63 GLICERINA, CAJA ACERO INOX AISI-304
TUBO BOURDON Y RACOR EN LATON ROSCA 1/4" MACHO GAS.
GRADUACIONES DISPONIBLES DE 0 A 2.5-4 A 6-10-16 SALIDA INFERIOR.

CABEZAL ROSCADO UNIVERSAL

“MODELO GA”



REFERENCIA	TUBERIA	ROSCA	EUROS
7301050	3/4"	50-200	20,00
7301080	1"	50-200	20,00
7301180	1 1/4"	80-300	22,00
7301280	1 1/2"	80-300	22,00
7301380	2"	80-300	22,00
CABR2080808	2 1/2"	125-700	56,00
CABR2080810	3"	125-700	69,00

BANDA DE ACERO INOXIDABLE PARA CABEZAL ROSCADO “MODELO GA”



REFERENCIA	RANGO	EUROS
GA055088	55-89	27,00
GA088118	89-119	29,00
GA105133	106-134	30,00
GA134160	134-160	31,00
GA157187	157-187	32,00
GA180216	187-217	35,00
GA211245	211-245	36,00
GA241271	241-271	38,00
GA266299	266-299	39,00
GA299330	300-331	41,00
GA316346	316-346	43,00
GA345361	345-361	44,00
GA399435	399-435	61,00
GA451485	451-485	64,00
GA499535	499-535	67,00
GA561595	561-595	72,00
GA621655	621-655	75,00
GA676710	676-710	78,00

CABEZAL BRIDA

“MODELO GA”



REFERENCIA	DN	TUBERIA	EUROS
CBGA050	50	80/700	56,00
CBGA065	60/65	100/700	69,00
CBGA080	80	125/700	91,00
CBGA100	100	150/500	118,00
CBGA150	150	300/500	205,00
CABB2020810	200 PN-10	450/1300	554,00
CABB2020811	200 PN-16	450/1300	554,00

COLLARÍN FUNDICIÓN DÚCTIL GGG-50 PARA TUBERIA PVC Y P.E. "MODELO GA"



- * TORNILLO INOX.
(4 UNIDADES)
- * PINTURA EPOXI
- * GOMA DE EPDM

REFERENCIA	TUBERIA	ROSCA	EUROS	REFERENCIA	TUBERIA	ROSCA	EUROS
CP300041	40	3/4"	11,87	CP301140	140	1 1/4"	41,55
CP300040	40	1"	11,87	CP302140	140	1 1/2"	41,70
CP300150	50	3/4"	12,69	CP303140	140	2"	42,10
CP300050	50	1"	12,69	CP305140	140	2 1/2"	52,57
CP300163	63	3/4"	14,86	CP306140	140	3"	52,99
CP300063	63	1"	14,86	CP304160	160	3/4"	52,93
CP300263	63	1 1/4"	15,34	CP300160	160	1"	52,93
CP300363	63	1 1/2"	15,42	CP301160	160	1 1/4"	53,51
CP300463	63	2"	15,85	CP302160	160	1 1/2"	53,70
CP300475	75	3/4"	16,37	CP303160	160	2"	54,10
CP300375	75	1"	16,37	CP305160	160	2 1/2"	66,70
CP300075	75	1 1/4"	16,83	CP306160	160	3"	67,16
CP300175	75	1 1/2"	16,95	CP304200	200	3/4"	63,47
CP300575	75	2"	17,35	CP300200	200	1"	63,47
CP300490	90	3/4"	18,84	CP301200	200	1 1/4"	63,93
CP300090	90	1"	18,84	CP302200	200	1 1/2"	64,08
CP300190	90	1 1/4"	19,30	CP303200	200	2"	64,46
CP300290	90	1 1/2"	19,46	CP305200	200	2 1/2"	73,59
CP300390	90	2"	19,82	CP306200	200	3"	73,83
CP304110	110	3/4"	23,43	CP304250	250	3/4"	129,83
CP300110	110	1"	23,43	CP300250	250	1"	129,83
CP301110	110	1 1/4"	23,91	CP301250	250	1 1/4"	130,50
CP302110	110	1 1/2"	24,01	CP302250	250	1 1/2"	130,60
CP303110	110	2"	24,39	CP303250	250	2"	131,09
CP304125	125	3/4"	30,20	CP305250	250	2 1/2"	131,39
CP300125	125	1"	30,20	CP306250	250	3"	131,64
CP301125	125	1 1/4"	30,75	CP304315	315	3/4"	159,48
CP302125	125	1 1/2"	30,90	CP300315	315	1"	159,48
CP303125	125	2"	31,33	CP301315	315	1 1/4"	160,16
CP305125	125	2 1/2"	46,87	CP302315	315	1 1/2"	160,31
CP306125	125	3"	47,30	CP303315	315	2"	160,80
CP304140	140	3/4"	40,94	CP305315	315	2 1/2"	161,07
CP300140	140	1"	40,94	CP306315	315	3"	161,32

COLLARÍN FUNDICIÓN SALIDA BRIDA "MOD. GA"



- * TORNILLO INOX.
- * PINTURA EPOXI
- * GOMA DE EPDM

REFERENCIA	TUBERIA	BRIDA	EUROS
CB125050	125	50/65	79,00
CB125080	125	80	93,00
CB160050	160	50/65	94,00
CB160080	160	80/100	98,00
CB200050	200	50/65	109,00
CB200080	200	80/100	116,00
CB200125	200	125/150	162,00
CB250050	250	50-65	150,00
CB250080	250	80/100	164,00
CB250125	250	125/150	216,00
CB315050	315	50-65	264,00
CB315080	315	80/100	274,00
CB315125	315	125/150	357,00
CB400080	400	80/100	315,00
CB400125	400	125/150	425,00
CB400200	400	200 PN-16	462,00
CB500080	500	80/100	415,00
CB500125	500	125/150	562,00
CB500200	500	200 PN-16	597,00

JUEGOS DE REGISTRO CIRCULAR EN FUNDICIÓN GRIS



REFERENCIA	MEDIDA	EUROS
JR577001	25	15,87
JR577002	30	21,36
JR577003	40	35,85
JR577004	50	68,51
JR577005	60	133,58
JR577006	70	200,36
JR577007	80	285,86

JUEGOS DE REGISTRO CUADRADOS EN FUNDICIÓN GRIS



REFERENCIA	MEDIDA	EUROS
JR577010	25X25	18,00
JR577011	30X30	22,00
JR577013	40X40	40,00
JR577013-A	50X50	72,00
JR577014	60X60	120,00
JR577015	70X70	240,00
JR577016	80X80	326,00

JUEGOS DE REGISTRO CUADRADOS CON TAPA CIRCULAR FUNDICIÓN GRIS



REFERENCIA	MEDIDA	EUROS
JR577019	40X40	56,00
JR577020	45X45	107,00
JR577021	60X60	209,00
JR577023	66X66	242,00

JUEGOS DE REGISTRO CUADRADOS CON TAPA CIRCULAR FUNDICIÓN GRIS

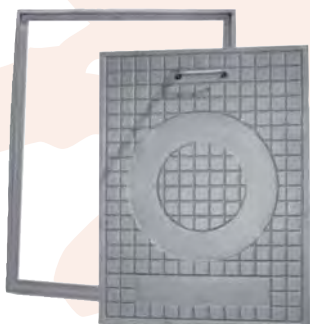

REFERENCIA	MEDIDA	EUROS
JR577024	40X60	98,00
JR577025	60X80	174,00
JR577026	40X50	79,00



JUEGO REGISTRO ACOMETIDA FUNDICIÓN GRIS GG-25

REFERENCIA	MEDIDA	EUROS
JR577028	15X15	8,32
JR577029	20X20	12,25



REJILLA TERRAZA FUNDICIÓN GRIS GG-25

REFERENCIA	MEDIDA	EUROS
JR577033	25X25	9,80
JR577034	30X30	12,89



JUEGOS IMBORNALES CURVOS FUNDICIÓN GRIS GG-25

REFERENCIA	MEDIDA	EUROS
JR577036	28X38	48,89
JR577038	35X40	83,38
JR577039	30X85	194,58

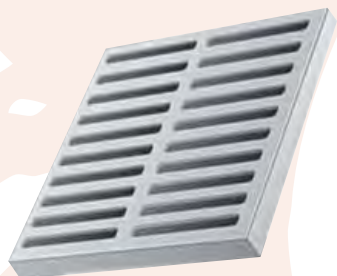

JUEGOS IMBORNALES RECTOS FUNDICIÓN GRIS GG-25

REFERENCIA	MEDIDA	EUROS
JR577040	18X38	24,44
JR577041	12X50	28,22
JR577042	14X54	45,85
JR577043	22X60	58,37
JR577044	25X45	54,99
JR577045	30X40	54,99
JR577046	30X50	61,15
JR577047	35X50	77,80
JR577048	50X50	107,58
JR577049	40X60	115,11
JR577050	40X70	120,09

REGISTRO EN ALUMINIO FUNDIDO

PUERTA DE CONTADOR PARA CANDADO DE ALUMINIO FUNDIDO



PUERTA DE CONTADOR CON CERRADURA Y LLAVE DE ALUMINIO FUNDIDO

REFERENCIA	MEDIDA	EUROS	REFERENCIA	MEDIDA	EUROS
PA572016	15X20	12,60	PA582016	15X20	12,60
PA572032	20X32	15,75	PA582032	20X32	15,75
PA573522	25X35	17,85	PA583522	25X35	17,85
PA574030	30X40	16,80	PA584030	30X40	19,57
			PA585026	25X50	29,40
			PA584446	40X43	46,20

REGISTRO CUADRADO CON TAPA CIRCULAR DE ALUMINIO FUNDIDO

ACCESORIOS DE ALUMINIO FUNDIDO



REFERENCIA	MEDIDA	EUROS	REFERENCIA	EUROS
PA602020	20X20	8,36	PA600001	CERRAD. 3,15
			PA600002	LLAVE 1,05
				PUERTA DE CONTADOR

REGISTRO CUADRADO ACERA DE ALUMINIO FUNDIDO



REFERENCIA	MEDIDA	EUROS
PA612020	20X20	11,00
PA613030	30X30	25,20
PA914040	40X40	42,00

SUMIDERO ALUMINIO FUNDIDO



REFERENCIA	MEDIDA	EUROS
SU561010	10X10	7,35
SU561515	15X15	8,40
SU562020	20X20	11,55
SU562525	25X25	15,75
SU563030	30X30	22,05
SU564040	40X40	39,90

SUMIDEROS DE PATIO EN HIERRO FUNDIDO MODELO TIPO MADRID



REFERENCIA	MEDIDA	EUROS
SU580150	15X15	7,71
SU580200	20X20	10,98
SU580250	25X25	17,67
SU580300	30X30	28,27
SU580440	40X40	126,00

SUMIDEROS DE PATIO EN HIERRO FUNDIDO MODELO TIPO CAMPANA



REFERENCIA	MEDIDA	EUROS
SU570150	150	7,87
SU570200	200	12,24
SU570250	250	18,83
SU570300	300	25,39
SU570400	400	50,30

SUMIDERO DE PATIO EN CHAPA DE ACERO ZINCADOS

SUMIDERO COMPLETO

TAPA SUMIDERO



REFERENCIA	MEDIDA	EUROS	REFERENCIA	MEDIDA	EUROS
SU571100	100x100	8,62	SU573100	100x100	3,64
SU571125	125x125	12,02	SU573125	125x125	5,26
SU571150	150x150	16,24	SU573150	150x150	6,77
SU571200	200x200	21,48	SU573200	200x200	9,80
SU571250	250x250	37,14	SU573250	250x250	17,33
SU571300	300x300	52,02	SU573300	300x300	22,61

SUMIDEROS DE PATIO EN CHAPA DE ACERO INOXIDABLES

SUMIDERO COMPLETO

TAPA SUMIDERO



REFERENCIA	MEDIDA	EUROS	REFERENCIA	MEDIDA	EUROS
SU572100	100x100	17,53	SU574100	100x100	6,71
SU572125	125x125	23,11	SU574125	125x125	8,28
SU572150	150x150	29,55	SU574150	150x150	10,54
SU572200	200x200	50,49	SU574200	200x200	18,08
SU572250	250x250	120,87	SU574250	250x250	48,24
SU572300	300x300	168,97	SU574300	300x300	69,35

REGISTRO CIRCULAR FUNDICIÓN DÚCTIL

REFERENCIA	DESCRIPCIÓN	EUROS
HFD400JC100	CON JUNTA P.E. Y CIERRE H100 D-400	203,45
HFD400JC75	CON JUNTA P.E. SIN CIERRE H60 D-400	98,45
HFD250JC35	SIN JUNTA TAPA 57 C-250	80,64

REGISTROS SANEAMIENTO Y ABASTECIMIENTO

D-400 (CALZADA)

CON CIERRE Y JUNTA
DE POLIETILENO D-400



REGISTRO MARCO Y TAPA CUADRADA FUNDICIÓN DÚCTIL C-250

REFERENCIA	MEDIDA	EUROS
HFH1300	30X30	29,00
HFH1400	40X40	41,89
HFH1500	50X50	76,50
HFH1600	60X60	102,85
HFH1700	70X70	182,16
HFH1800	80X80	216,48

REGISTRO MARCO Y TAPA CUADRADA FUNDICIÓN DÚCTIL D-400

REFERENCIA	MEDIDA	EUROS
HFH2400	40X40	71,35
HFH2500	50X50	105,57
HFH2600	60X60	192,45
HFH2700	70X70	216,48
HFH2800	80X80	330,00
HFH21000	100X100	528,00

REGISTRO ACERA MARCO Y TAPA CUADRADA FUNDICIÓN DÚCTIL B-125

REFERENCIA	MEDIDA	EUROS
HFH300	30X30	21,42
HFH400	40X40	32,73
HFH500	50X50	63,27
HFH600	60X60	84,29
HFH700	70X70	151,20
HFH800	80X80	197,80
HFH900	90X90	275,36
HFH1000	100X100	428,40

**B-125 (ACERA)
SERIE HIDRÁULICA**

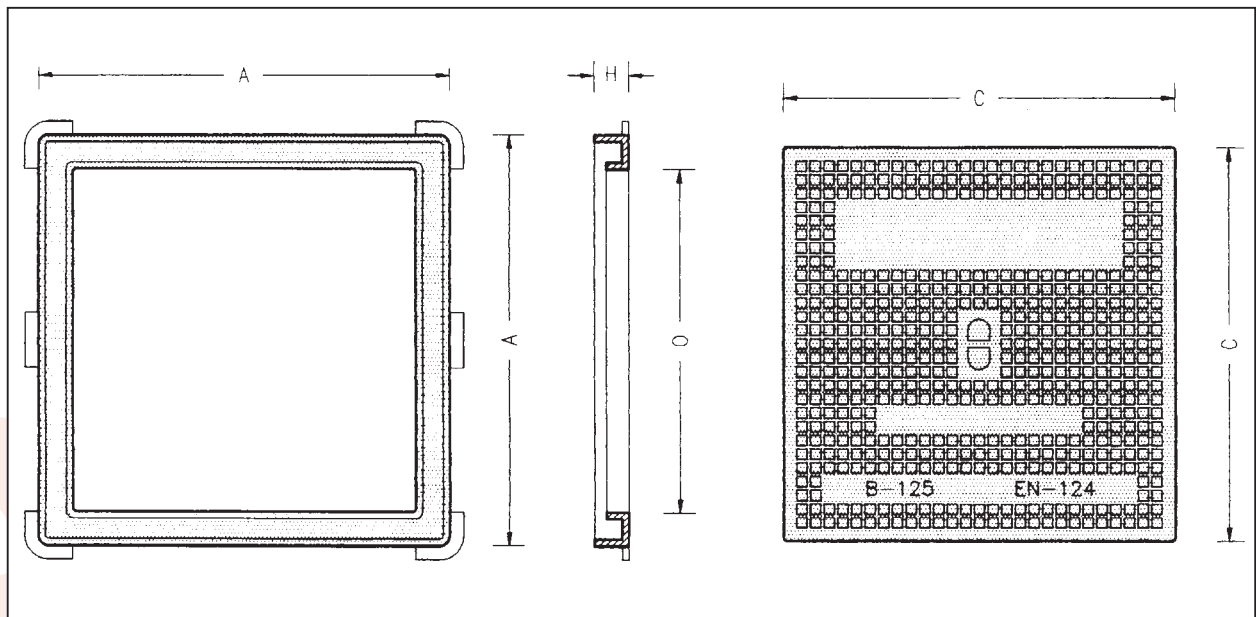

REFERENCIA	DIMENSIONES mm.				EUROS
	A	O	C	H	
HFH300	300	235	285	23	21,42
HFH400	400	348	387	25	32,73
HFH500	500	435	480	30	63,27
HFH600	600	500	580	33	84,29
HFH700	700	600	680	35	151,20
HFH800	800	700	780	40	197,80

ACCESORIO DE LATÓN DESMONTABLE PARA MANGUERA DE POLIETILENO ROSCA INTERIOR "MODELO GA"



RACOR ROSCA MACHO

RACOR ROSCA HEMBRA



REFERENCIA	MEDIDA	UDS CAJA	EUROS	REFERENCIA	MEDIDA	UDS CAJA	EUROS
AD800020	20-1/2"	100	3,09	AD801020	20-1/2"	100	3,24
AD800025	25-3/4"	80	4,03	AD801025	25-3/4"	80	4,03
AD800032	32-1"	70	5,93	AD801032	32-1"	70	6,21
AD800040	40-1 1/4"	40	10,15	AD801040	40-1 1/4"	40	10,34
AD800050	50-1 1/2"	30	13,73	AD801050	50-1 1/2"	30	14,56
AD800063	63-2"	15	25,21	AD801063	63-2"	15	26,68
AD800075	75-2 1/2"	8	54,4	AD801075	75-2 1/2"	8	54,00
AD800090	90-3"	4	66,18	AD801090	90-3"	4	71,35
AD800110	110-4"	2	124,17	AD801110	110-4"	2	128,21



UNIÓN MANGUERA

CODO DESMONTABLE



REFERENCIA	MEDIDA	UDS CAJA	EUROS	REFERENCIA	MEDIDA	UDS CAJA	EUROS
AD802020	20	60	5,66	AD803020	20	60	5,66
AD802025	25	50	6,45	AD803025	25	40	8,62
AD802032	32	30	9,70	AD803032	32	30	11,59
AD802040	40	25	16,58	AD803040	40	20	20,50
AD802050	50	20	24,26	AD803050	50	12	30,44
AD802063	63	10	41,79	AD803063	63	10	45,83
AD802075	75	4	89,99	AD803075	75	3	110,89
AD802090	90	4	107,03	AD803090	90	1	150,67
AD802110	110	2	206,51	AD803110	110	1	237,60

CODO CON BOCA DESMONTABLE Y ROSCA MACHO



REFERENCIA	MEDIDA	UDS CAJA	EUROS
AD804020	20-1/2"	100	3,79
AD804025	25-3/4"	60	5,50
AD804032	32-1"	50	8,50
AD804040	40-1 1/4"	25	14,81
AD804050	50-1 1/2"	15	20,65
AD804063	63-2"	10	35,58
AD804075	75-2 1/2"	4	73,34
AD804090	90-3"	2	96,35

ACCESORIO DE LATÓN DESMONTABLE PARA MANGUERA DE POLIETILENO ROSCA INTERIOR "MODELO GA"



**CODO BOCA DESMONTABLE
Y ROSCA HEMBRA**

**ENLACES EN "T" TRES
BOCAS MANGUERAS**



REFERENCIA	MEDIDA	UDS CAJA	EUROS	REFERENCIA	MEDIDA	UDS CAJA	EUROS
AD805020	20-1/2"	100	4,25	AD806020	20	40	8,62
AD805025	25-3/4"	60	5,11	AD806025	25	30	10,77
AD805032	32-1"	50	9,05	AD806032	32	20	16,70
AD805040	40-1 1/4"	25	14,81	AD806040	40	12	26,40
AD805050	50-1 1/2"	15	20,22	AD806050	50	8	40,36
AD805063	63-2"	10	39,62	AD806063	63	4	72,52
AD805075	75-2 1/2"	4	71,48	AD806075	75	2	144,98
AD805090	90-3"	2	100,58	AD806090	90	1	199,84
				AD806110	110	1	274,00



**TE CON BOCA DESMONTABLE
Y ROSCA HEMBRA**

**TE CON BOCA DESMONTABLE
Y ROSCA MACHO**



REFERENCIA	MEDIDA	UDS CAJA	EUROS	REFERENCIA	MEDIDA	UDS CAJA	EUROS
AD807020	20	50	6,88	AD809020	20	50	6,42
AD807025	25	30	9,30	AD809025	25	30	8,62
AD807032	32	25	14,29	AD809032	32	25	13,73
AD807040	40	15	23,59	AD809040	40	15	22,64
AD807050	50	8	31,02	AD809050	50	8	30,84
AD807063	63	6	58,50	AD809063	63	6	52,57
AD807075	75	2	117,93	AD809075	75	2	139,10
AD807090	90	1	167,44	AD809090	90	1	189,20

CODO MURAL CON BOCA DESMONTABLE Y ROSCA HEMBRA



REFERENCIA	MEDIDA	UDS CAJA	EUROS
AD811020	20	70	5,93
AD811025	25	40	8,50
AD811032	32	25	11,32

ACCESORIO DE LATÓN DEMONTABLE PARA MANGUERA DE POLIETILENO SERIE "S" ROSCA EXTERIOR "MODELO GA"



RACOR ROSCA MACHO

RACOR ROSCA HEMBRA

REFERENCIA	MEDIDA	UDS CAJA	EUROS	REFERENCIA	MEDIDA	UDS CAJA	EUROS
DE810020	20-1/2"	120	2,26	DE820020	20-1/2"	120	2,59
DE810025	25-3/4"	100	3,19	DE820025	25-3/4"	100	3,74
DE810032	32-1"	60	5,87	DE820032	32-1"	60	6,15
DE810040	40-1 1/4"	30	8,26	DE820040	40-1 1/4"	30	8,53
DE810050	50-1 1/2"	24	13,28	DE820050	50-1 1/2"	30	14,23
DE810063	63-2"	12	22,46	DE820063	63-2"	12	25,03



UNIÓN MANGUERA

ENLACE EN "T" TRES BOCAS MANGUERA

REFERENCIA	MEDIDA	UDS CAJA	EUROS	REFERENCIA	MEDIDA	UDS CAJA	EUROS
DE830020	20	100	3,97	DE840020	20	60	6,85
DE830025	25	60	5,63	DE840025	25	30	9,48
DE830032	32	30	8,93	DE840032	32	20	16,09
DE830040	40	30	13,52	DE840040	40	12	24,75
DE830050	50	20	21,75	DE840050	50	8	38,28
DE830063	63	10	35,77	DE840063	63	5	62,60



ENLACES EN "T" DOS BOCAS MANGERA Y UNA ROSCADA HEMBRA

ENLACE EN "T" DOS BOCAS MANGERA Y UNA ROSCADA MACHO

REFERENCIA	MEDIDA	UDS CAJA	EUROS	REFERENCIA	MEDIDA	UDS CAJA	EUROS
DE850020	20	60	5,66	DE880220	20-1/2"	60	5,23
DE850025	25	30	7,92	DE880225	25-3/4"	30	7,68
DE850032	32	20	13,80	DE880232	32-1"	20	12,30
DE850040	40	12	20,93	DE880240	40-1 1/4"	12	20,83
DE850050	50	8	33,23	DE880250	50-1 1/2"	8	31,92
DE850063	63	5	53,64	DE880263	63-2"	5	51,07

ACCESORIO DE LATÓN DEMONTABLE PARA MANGUERA DE POLIETILENO ROSCA EXTERIOR “MODELO GA”



**CODO BOCA DESMONTABLE
Y ROSCA MACHO**



**CODO BOCA DESMONTABLE
Y ROSCA HEMBRA**

REFERENCIA	MEDIDA	UDS CAJA	EUROS	REFERENCIA	MEDIDA	UDS CAJA	EUROS
DE870020	20-1/2"	100	3,19	DE880020	20-1/2"	100	3,19
DE870025	25-3/4"	60	5,39	DE880025	25-3/4"	60	5,05
DE870032	32-1"	40	8,93	DE880032	32-1"	40	8,53
DE870040	40-1 1/4"	20	13,80	DE880040	40-1 1/4"	20	13,04
DE870050	50-1 1/2"	12	21,75	DE880050	50-1 1/2"	12	24,23
DE870063	63-2"	8	31,94	DE880063	63-2"	8	35,40

CODO IGUAL DESMONTABLE



REFERENCIA	MEDIDA	UDS CAJA	EUROS
DE880120	20	100	4,74
DE880125	25	40	6,85
DE880132	32	30	11,47
DE880140	40	20	18,42
DE880150	50	12	29,10
DE880163	63	7	43,94

CODO MURAL ROSCA HEMBRA



REFERENCIA	MEDIDA	UDS CAJA	EUROS
DE880191	20	100	4,00
DE880190	25	50	6,67
DE810192	32	30	9,70

ACCESORIOS DE LATÓN

CONTRA ROSCA MACHO-MACHO



REFERENCIA	MEDIDA	EUROS
AL 474200	1/8"	0,86
AL 474201	1/4"	0,90
AL 474202	3/8"	0,98
AL 474203	1/2"	1,18
AL 474204	3/4"	2,01
AL 474205	1"	3,50
AL 474206	1 1/4"	5,94
AL 474207	1 1/2"	7,75
AL 474208	2"	12,46
AL 474209	2" X 1 1/2"	20,32
AL 474210	3"	32,27
AL 474410	4"	110,52

REDUCCIÓN HEXAGONAL MACHO-HEMBRA

REFERENCIA	MEDIDA	EUROS
AL 474212R	1/8" X 1/4"	1,07
AL 474211	3/8" X 1/8"	0,93
AL 474212	3/8" X 1/4"	0,83
AL 474213	1/2" X 1/8"	1,50
AL 474214	1/2" X 1/4"	1,15
AL 474215	1/2" X 3/8"	1,03
AL 474216	3/4" X 1/2"	1,28
AL 474217	1" X 1/2"	2,53
AL 474218	1" X 3/4"	2,14
AL 474019	1 1/4" X 1/2"	4,74
AL 474219	1 1/4" X 3/4"	4,64
AL 474220	1 1/4" X 1"	3,85
AL 474221	1 1/2" X 1/2"	7,09
AL 474222	1 1/2" X 3/4"	7,02
AL 474223	1 1/2" X 1"	6,47
AL 474224	1 1/2" X 1 1/4"	4,73
AL 474225	2" X 1/2"	12,19
AL 474226	2" X 3/4"	13,42
AL 474227	2" X 1"	9,42
AL 474228	2" X 1 1/4"	10,65
AL 474229	2" X 1 1/2"	8,38
AL 474230	2 1/2" X 2"	17,96
AL 474231	3" X 2 1/2"	33,62
AL 474232	3" X 2"	38,01
AL 474333	4" X 2"	84,21
AL 474334	4" X 2 1/2"	78,94
AL 474335	4" X 3"	72,38

CONTRAROSCA REDUCCION MACHO-MACHO



REFERENCIA	MEDIDA	EUROS
AL 474130	1/8" X 3/8"	1,36
AL 474131	1/8" X 1/4"	0,89
AL 474250	1/2" X 1/4"	1,30
AL 474132	1/4" X 3/8"	1,05
AL 474233	3/8" X 1/2"	1,36
AL 474234	1/2" X 3/4"	1,60
AL 474235	1/2" X 1"	2,83
AL 474253	1/2" X 1"1/4	4,85
AL 474236	1/2" X 1 1/2"	6,21
AL 474237	3/4" X 1"	2,93
AL 474238	3/4" X 1 1/4"	4,40
AL 474239	3/4" X 1 1/2"	5,93
AL 474240	3/4" X 2"	9,48
AL 474241	1" X 1"1/4	4,72
AL 474242	1" X 1"1/2	5,99
AL 474243	1" X 2"	10,03
AL 474244	1 1/4" X 1 1/2"	6,87
AL 474245	1 1/4" X 2"	10,03
AL 474246	1 1/2" X 2"	10,38
AL 474247	2" X 2 1/2"	20,07
AL 474248	2" X 3"	31,04
AL 474249	2 1/2" X 3"	30,36
AL 474251	2 1/2" X 4"	100,80
AL 474252	3" X 4"	106,91

TAPON MACHO

REFERENCIA	MEDIDA	EUROS
AL 474300	1/8"	0,55
AL 474301	1/4"	0,73
AL 474302	3/8"	0,79
AL 474303	1/2"	0,97
AL 474304	3/4"	1,50
AL 474305	1"	2,37
AL 474306	1 1/4"	3,43
AL 474307	1 1/2"	5,00
AL 474308	2"	7,18
AL 474309	2 1/2"	19,19
AL 474321	3"	24,64
AL 474322	4"	107,62



ACCESORIOS DE LATÓN

BEBEDEROS AUTOMÁTICOS PARA CERDOS



REFERENCIA	MEDIDA	EUROS
AL470700	1/2"	3,80

RACOR URALITA (CUERPO Y TUERCA CORREDERA)



REFERENCIA	MEDIDA	EUROS
AL476040	3/8"	2,32
AL476041	1/2"	3,12
AL476042	3/4"	4,69
AL476043	1"	6,08
AL476044	1 1/4"	9,97
AL476045	1 1/2"	14,74
AL476046	2"	26,96

CUERPO RACOR URALITA NORMAL



REFERENCIA	MEDIDA	EUROS
AL476050	3/8"	1,69
AL476051	1/2"	2,34
AL476052	3/4"	3,27
AL476053	1"	4,68
AL476054	1 1/4"	7,80
AL476055	1 1/2"	11,32
AL476056	2"	19,02

BOYA EXPANDIDA



GUIA DE LATÓN PARA BOYA

REFERENCIA	MEDIDA	EUROS	REFERENCIA	MEDIDA	EUROS
AL470012	1/2"	3,24	AL470002	1/2"	9,18
AL470013	3/4"	4,13	AL470003	3/4"	12,46
AL470014	1"	5,72	AL474004	1"	19,36
AL470015	1 1/4" - 1 1/2"	8,15	AL474005	1 1/4"	46,32
AL474015	2"	11,82	AL474006	1 1/2"	53,80
			AL474007	2"	78,82

ACCESORIOS DE LATÓN

BOCA DE RIEGO HORIZONTAL (EMPALME RACOR BARCELONA)



REFERENCIA	MEDIDA	EUROS
AL475005	1/2"	23,62
AL475006	3/4"	36,18
AL475007	1"	50,45
AL475009	1 1/2"	184,20

BOCA DE RIEGO VERTICAL (EMPALME RACOR BARCELONA)



REFERENCIA	MEDIDA	EUROS
AL475010	1/2"	24,07
AL475011	3/4"	34,28
AL475012	1"	48,74
AL475014	1 1/2"	167,15

BOCA DE RIEGO HORIZONTAL (EMPALME RACOR MANGUERA)



REFERENCIA	MEDIDA	EUROS
AL475020	1/2"	19,22
AL475021	3/4"	29,26
AL475022	1"	42,23
AL475024	1 1/2"	158,36

BOCA DE RIEGO VERTICAL (EMPALME RACOR MANGUERA)



REFERENCIA	MEDIDA	EUROS
AL475000	1/2"	19,65
AL475001	3/4"	26,38
AL475002	1"	40,54
AL475004	1 1/2"	141,37

ACCESORIOS DE LATÓN

RACOR BARCELONA ROSCA M-M



REFERENCIA	MEDIDA	EUROS
AL477068	1/2"	6,80
AL477069	3/4"	9,95
AL477070	1"	12,10
AL477071	1 1/4"	19,08
AL477072	1 1/2"	27,10
AL477073	2"	42,26

RACOR BARCELONA EMPALME (MANGUERA - MANGUERA)



REFERENCIA	MEDIDA	EUROS
AL475100	20X20	6,92
AL475101	25X25	9,95
AL475102	30X30	11,98
AL475103	35X35	22,58
AL475104	40X40	28,32
AL475105	45X45	35,12
AL475106	50X50	49,20
AL475107	60X60	54,69
AL475108	70X70	61,95

RACOR DOS PIEZAS MANGUERA



REFERENCIA	MEDIDA	EUROS
AL477075	14 - 1/2"	2,39
AL477076	16 - 5/8"	2,82
AL477077	20 - 3/4"	3,17
AL477078	25 - 1"	4,41
AL477079	30 - 1 1/4"	7,09
AL477080	35 - 1 1/2"	10,25
AL477081	50 - 2"	24,78

RACOR TRES PIEZAS MANGUERA



REFERENCIA	MEDIDA	EUROS
AL477082	1/2"	5,52
AL477083	5/8"	7,68
AL477084	3/4"	8,20
AL477085	1"	12,35
AL477086	1 1/4"	16,61
AL477087	1 1/2"	21,78

ACCESORIOS DE LATÓN CONEXIONES PARA AIRE Y AGUA



REFERENCIA	MEDIDA	EUROS
AL474850	3/4" MACHO	10,78
AL474851	3/4" HEMBRA	9,79
AL474852	MANGUERA 3/4"	13,57

LANZA MANGUERA 3 EFECTOS



REFERENCIA	MEDIDA	EUROS
AL474401	20 MM	11,92
AL474402	25 MM	12,46

PITONES RIEGO PARA MANGUERA



REFERENCIA	MEDIDA	EUROS
AL474404	20 MM	6,98
AL474405	25 MM	11,46
AL474406	29 MM	16,18
AL474407	35 MM	31,92

TUERCAS PARA RACOR



REFERENCIA	MEDIDA	EUROS
AL477088	3/8"	0,71
AL477089	1/2"	0,99
AL477090	3/4"	1,30
AL477091	1"	1,90
AL477092	1 1/4"	2,86
AL477093	1 1/2"	4,17
AL477094	2"	6,08

CONO RACOR MANGUERA



REFERENCIA	MEDIDA	EUROS
AL477095	3/8" - 13	1,63
AL477096	1/2" - 20	1,99
AL477098	3/4" - 22,5	2,69
AL477099	1" - 30	4,87
AL477100	1 1/4" - 35	7,59
AL477101	1 1/2" - 47	13,55
AL477102	2" - 58	19,83

ACCESORIOS DE LATÓN

CODO HEMBRA-HEMBRA CODO MACHO-HEMBRA



REFERENCIA	MEDIDA	EUROS	REFERENCIA	MEDIDA	EUROS
AL474600	3/8"	1,83	AL474610	3/8"	1,77
AL474601	1/2"	2,80	AL474611	1/2"	2,89
AL474602	3/4"	4,20	AL474612	3/4"	4,55
AL474603	1"	7,67	AL474613	1"	7,49
AL474604	1 1/4"	12,57	AL474614	1 1/4"	12,25
AL474605	1 1/2"	17,83	AL474615	1 1/2"	18,63
AL474606	2"	28,28	AL474616	2"	25,29
AL474607	2 1/2"	52,67	AL474617	2 1/2"	64,23
AL474608	3"	92,93	AL474618	3"	96,77
AL474609	4"	162,25	AL474619	4"	178,44

MANGUITO HEMBRA-HEMBRA



MANGUITO REDUCCIÓN HEMBRA-HEMBRA

REFERENCIA	MEDIDA	EUROS	REFERENCIA	MEDIDA	EUROS
AL 474800	3/8"	1,59	AL 474810	3/8" X 1/2"	1,67
AL 474801	1/2"	1,85	AL 474811	1/2" X 3/4"	2,78
AL 474802	3/4"	2,66	AL 474809	1/2" X 1"	2,99
AL 474803	1"	3,93	AL 474812	3/4" X 1"	3,26
AL 474804	1 1/4"	6,96	AL 474813	1" X 1 1/4"	5,39
AL 474805	1 1/2"	9,69	AL 474814	1 1/4" X 1 1/2"	7,50
AL 474806	2"	17,39	AL 474815	1" X 2"	9,86
AL 474807	2 1/2"	35,10	AL 474816	1 1/4" X 2"	10,49
AL 474808	3"	63,15	AL 474817	1 1/2" X 2"	12,18
AL 474799	4"	118,84			

RACOR MARSELLA REDUCCIÓN MACHO-HEMBRA



REFERENCIA	MEDIDA	EUROS	REFERENCIA	MEDIDA	EUROS
AL474957	3/8" M X 1/2" H	1,30	AL474970	1" M X 3/4 H	4,48
AL474958	1/2" M X 3/4" H	1,70	AL474971	1" M X 1"1/4 H	6,70
AL474959	1/2" M X 1" H	2,68	AL474972	1" M X 1"1/2 H	7,22
AL474965	3/4" M X 1" H	2,98	AL474974	1"1/4 M X 1"1/2 H	9,50
AL474966	3/4" M X 1 1/4" H	4,57	AL474976	1"1/2 M X 2" H	10,96

ACCESORIOS DE LATÓN TES HEMBRA-HEMBRA-HEMBRA



REFERENCIA	MEDIDA	EUROS
AL474900	3/8"	2,31
AL474901	1/2"	3,39
AL474902	3/4"	4,79
AL474903	1"	8,53
AL474904	1 1/4"	14,52
AL474905	1 1/2"	24,05
AL474906	2"	36,22
AL474907	2 1/2"	75,98
AL474908	3"	120,63
AL474909	4"	215,94

TES HEMBRA-HEMBRA REDUCIDA



REFERENCIA	MEDIDA	EUROS
AL477112	3/4" - 1/2" - 3/4"	5,04
AL477113	1" - 1/2" - 1"	6,78
AL477114	1" - 3/4" - 1"	7,27
AL476224	1 1/4" - 1/2" - 1 1/4"	18,45
AL477115	1 1/4" - 3/4" - 1 1/4"	16,83
AL476225	1 1/4" - 1" - 1 1/4"	15,15
AL477116	1 1/2" - 1/2" - 1 1/2"	17,06
AL477117	1 1/2" - 3/4" - 1 1/2"	15,98
AL477118	1 1/2" - 1" - 1 1/2"	16,02
AL477119	1 1/2" - 1 1/4" - 1 1/2"	25,18
AL477220	2" - 1/2" - 2"	27,54
AL477221	2" - 3/4" - 2"	23,70
AL477222	2" - 1" - 2"	23,16
AL476226	2" - 1 1/4" - 2"	30,30
AL477223	2" - 1 1/2" - 2"	37,05

UNIÓN HEMBRA-HEMBRA 3 PIEZAS



REFERENCIA	MEDIDA	EUROS
AL474700	1/2"	7,64
AL474701	3/4"	11,27
AL474702	1"	13,49
AL474703	1 1/4"	21,70
AL474704	1 1/2"	27,48
AL474705	2"	29,08
AL474706	2 1/2"	111,13

UNIÓN MACHO-HEMBRA 3 PIEZAS



REFERENCIA	MEDIDA	EUROS
AL474111	1/2"	7,62
AL474112	3/4"	11,26
AL474113	1"	14,76
AL474114	1 1/4"	23,78
AL474115	1 1/2"	30,12
AL474116	2"	33,70
AL474117	2 1/2"	114,27

ACCESORIOS DE LATÓN TAPÓN HEMBRA



REFERENCIA	MEDIDA	EUROS
AL 474312	3/8"	0,69
AL 474313	1/2"	0,94
AL 474314	3/4"	1,27
AL 474315	1"	2,09
AL 474316	1 1/4"	3,44
AL 474317	1 1/2"	4,25
AL 474318	2"	7,53
AL 474319	2 1/2"	12,82
AL 474320	3"	20,59
AL 475320	4"	82,34



CAÑAMO Y TEFLÓN



REFERENCIA	MEDIDA	EUROS
CT 477061	CAÑAMO 250 GRS	3,25
CT 477062	TEFLON PEQUEÑO	0,45
CT 477063	TEFLON GRANDE	3,80



PATES DE POLIPROPILENO PARA POZOS DE REGISTRO

REFERENCIA	EUROS
BA610005	6,30



GRIFO DE LATÓN CODO PRESIÓN

REFERENCIA	MEDIDA	EUROS
AL477063	1/2"	14,73
AL477064	3/4"	19,73



GRIFOS DE LATÓN CON RACOR MANGUERA

REFERENCIA	MEDIDA	EUROS
AL477065	1/2"	20,63
AL477066	3/4"	27,43
AL477067	1"	50,20

ACCESORIOS DE LATÓN



VÁLVULA DE PIE MALLA INOXIDABLE

FILTRO ACERO INOXIDABLE

REFERENCIA	MEDIDA	EUROS	REFERENCIA	MEDIDA	EUROS
VL470030	3/8"	4,05	VL470710	3/8"	0,62
VL470031	1/2"	4,15	VL470711	1/2"	0,62
VL470032	3/4"	5,67	VL470712	3/4"	0,70
VL470033	1"	7,40	VL470713	1"	0,86
VL470034	1 1/4"	11,14	VL470714	1 1/4"	1,26
VL470035	1 1/2"	16,44	VL470715	1 1/2"	1,65
VL470036	2"	25,07	VL470716	2"	2,26
VL470037	2 1/2"	54,25	VL470717	2 1/2"	3,20
VL470038	3"	77,42	VL470718	3"	3,96
VL470039	4"	134,52	VL470719	4"	5,83



VÁLVULA DE RETENCIÓN

VÁLVULA COMPUERTA LATÓN CIERRE DE GOMA

REFERENCIA	MEDIDA	EUROS	REFERENCIA	MEDIDA	EUROS
VL470150	3/8"	4,48	VL470070	1/2"	7,46
VL470151	1/2"	4,87	VL470071	3/4"	10,40
VL470152	3/4"	6,65	VL470072	1"	15,20
VL470153	1"	8,67	VL470073	1 1/4"	26,40
VL470154	1 1/4"	13,05	VL470074	1 1/2"	32,46
VL470155	1 1/2"	19,40	VL470075	2"	45,04
VL470156	2"	29,52	VL470076	2 1/2"	101,65
VL470157	2 1/2"	63,90	VL470077	3"	148,83
VL470158	3"	91,07			
VL470159	4"	158,24			



VÁLVULA ESFERA BRONCE CON CUADRADILLO

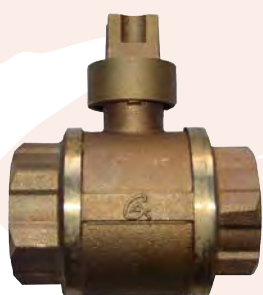

REFERENCIA	MEDIDA	EUROS
VL475001	1/2"	26,07
VL475002	3/4"	37,71
VL475003	1"	48,43
VL475004	1 1/4"	77,78
VL475005	1 1/2"	110,64
VL475006	2"	153,48

ACCESORIOS DE LATÓN COLLARINES DE LATÓN



REFERENCIA	MEDIDA	EUROS	REFERENCIA	MEDIDA	EUROS
VL477224	20 - 1/2"	6,40	VL477101	63 - 1/2"	22,04
VL477225	25 - 1/2"	6,72	VL477102	63 - 3/4"	21,58
VL477226	32 - 1/2"	8,65	VL477229	63 - 1"	21,70
VL477108	32 - 3/4"	9,16	VL477103	75 - 3/4"	37,66
VL477110	40 - 1/2"	13,62	VL477104	75 - 1"	36,58
VL477227	40 - 3/4"	12,95	VL477105	90 - 1/2"	55,54
VL477228	50 - 1/2"	13,90	VL477106	90 - 3/4"	48,04
VL477109	50 - 3/4"	13,06	VL477107	90 - 1"	49,68
VL477000	50 - 1"	13,38			

FILTROS EN Y EN LATÓN, CON MALLA INOX



REFERENCIA	MEDIDA	EUROS
VL477232	1/2"	5,60
VL477233	3/4"	7,09
VL477234	1"	9,78
VL477235	1 1/4"	18,89
VL477236	1 1/2"	23,83
VL477237	2"	40,75
VL477018	2 1/2"	87,34
VL477238	3"	102,22
VL478239	4"	204,44

VÁLVULA DE RETENCIÓN LATÓN TIPO YORK



REFERENCIA	MEDIDA	EUROS
VL477239	1/2"	4,65
VL477240	3/4"	6,47
VL477241	1"	8,60
VL477242	1 1/4"	12,34
VL477243	1 1/2"	18,73
VL477244	2"	28,33
VL477245	2 1/2"	59,34
VL477246	3"	73,44
VL477247	4"	125,20

VÁLVULA DE LATÓN RETENCIÓN CLAPETA DE METAL



REFERENCIA	MEDIDA	EUROS
VL477248	1/2"	5,70
VL477249	3/4"	8,03
VL477250	1"	11,52
VL477251	1 1/4"	17,56
VL477252	1 1/2"	23,50
VL477253	2"	40,16
VL477254	2 1/2"	63,38
VL477255	3"	94,54
VL478256	4"	164,27



TOMA MANGUERA BOCA RIEGO TIPO MADRID

REFERENCIA		EUROS
AL477258	CURVO	77,95

VÁLVULA DE ESFERA PALANCA ROSCA HEMBRA-HEMBRA



REFERENCIA	MEDIDA	EUROS
VE470011	1/2"	3,20
VE470012	3/4"	4,28
VE470013	1"	7,69
VE470014	1 1/4"	13,35
VE470015	1 1/2"	17,80
VE470016	2"	27,64
VE470017	2 1/2"	59,64
VE470018	3"	76,15
VE470019	4"	120,56



VÁLVULA ESFERA ACCIONAM. MARIPOSA

VÁLVULA ESFERA ACCIONAM. CUADRADILLO



REFERENCIA	MEDIDA	EUROS	REFERENCIA	MEDIDA	EUROS
VE477260	1/2"	3,27	VE457001	1/2"	4,75
VE477261	3/4"	4,41	VE457002	3/4"	6,68
VE477262	1"	6,90	VE457003	1"	9,80
			VE457004	1 1/4"	14,33
			VE457005	1 1/2"	24,08
			VE457006	2"	32,20



GRIFO DE ESFERA CON PALANCA

REFERENCIA	MEDIDA	EUROS
VE477263	1/2"	3,99
VE477264	3/4"	5,78
VE477265	1"	10,26

VÁLVULA COMPUERTA LATÓN CIERRE LATÓN



REFERENCIA	MEDIDA	EUROS
VL477267	1/2"	4,86
VL477268	3/4"	5,81
VL477269	1"	8,03
VL477270	1 1/4"	9,83
VL477271	1 1/2"	12,87
VL477272	2"	21,50
VL477273	2 1/2"	46,87
VL477274	3"	59,90
VL477275	4"	95,92



VÁLVULA ASIENTO INCLINADO EN LATÓN

VÁLVULA ESFERA ANTIRRETORNO

REFERENCIA	MEDIDA	EUROS	REFERENCIA	MEDIDA	EUROS
VL477276	1/2"	9,08	VL477282	1/2"	22,08
VL477277	3/4"	12,87	VL477283	3/4"	27,56
VL477278	1"	20,81	VL477284	1"	43,54
VL477279	1 1/4"	34,09	VL477285	1 1/4"	63,01
VL477280	1 1/2"	46,23	VL477286	1 1/2"	111,61
VL477281	2"	73,88	VL477287	2"	162,45



REDUCTORES DE PRESIÓN ASIENTO INOXIDABLE



REFERENCIA	MEDIDA	EUROS
RP477288	20	31,30
RP477289	25	32,10
RP477290	32	57,32
RP477291	40	100,22
RP477292	50	142,87
RP477293	60	216,24



HIDRANTE BAJO RASANTE GEISER (UNE 23.407) CON ARQUETA COMPLETA

REFERENCIA	PASO DN-80 CON BOCA DE 1 1/2" (45 MM)	EUROS
HI192072	RACOR TAPA UNE	475,00



HIDRANTE BAJO RASANTE GEISER (UNE 23.407) CON ARQUETA COMPLETA

REFERENCIA	PASO DN-80 CON BOCA DE 2 1/2" (70 MM)	EUROS
HI192073	RACOR TAPA UNE	483,00



HIDRANTE COLUMNA SECA TIFÓN PLUS

REFERENCIA	PASO	Nº BOCAS	EUROS
HI192200	80	3	842,00
HI190280	100	3	847,00



FANAL DE PROTECCIÓN

REFERENCIA	EUROS
HI193300	337,00

HIDRANTE BAJO RASANTE GEISER (UNE 23.407) CON ARQUETA COMPLETA



HIDRANTE DN-100 2 TOMAS DN-70

REFERENCIA			EUROS
HI192070	RACOR	UNE	607,50



HIDRANTE DN-100 1 TOMA DN-70

REFERENCIA			EUROS
HI194100	RACOR	UNE	545,40



HIDRANTE DN-100 1 TOMA DN-100

REFERENCIA			EUROS
HI192174	RACOR	UNE	585,00

ACCESORIOS EN HIERRO GALVANIZADO

TE 90° IGUAL

CRUZ IGUAL



REFERENCIA	MEDIDA	EUROS	REFERENCIA	MEDIDA	EUROS
AH690031	1/4"	1,74	AH690304	1/2"	3,19
AH690032	3/8"	1,46	AH690305	3/4"	4,75
AH690033	1/2"	0,92	AH690306	1"	5,79
AH690034	3/4"	1,36	AH690307	1 1/4"	8,17
AH690035	1"	2,05	AH690308	1 1/2"	11,03
AH690036	1 1/4"	3,83	AH690309	2"	17,11
AH690037	1 1/2"	5,02	AH690310	2 1/2"	40,28
AH690038	2"	7,56	AH690311	3"	46,70
AH690039	2 1/2"	25,73	AH690312	4"	67,38
AH690040	3"	30,22			
AH690041	4"	54,32			

MANGUITO ROSCA HEMBRA

MACHÓN DOBLE ROSCA MACHO



REFERENCIA	MEDIDA	EUROS	REFERENCIA	MEDIDA	EUROS
AH690050	1/4"	0,98	AH690061	1/4"	1,31
AH690051	3/8"	0,98	AH690062	3/8"	1,19
AH690052	1/2"	0,64	AH690063	1/2"	0,65
AH690053	3/4"	0,79	AH690064	3/4"	0,77
AH690054	1"	1,03	AH690065	1"	1,05
AH690055	1 1/4"	1,89	AH690066	1 1/4"	2,02
AH690056	1 1/2"	2,57	AH690067	1 1/2"	2,54
AH690057	2"	4,14	AH690068	2"	4,10
AH690058	2 1/2"	14,35	AH690069	2 1/2"	12,35
AH690059	3"	18,61	AH690070	3"	19,22
AH690060	4"	37,92	AH690071	4"	35,88

ACCESORIOS EN HIERRO GALVANIZADO



**CODO 90° ROSCA
HEMBRA-HEMBRA**



**CODO 90° ROSCA
MACHO-HEMBRA**

REFERENCIA	MEDIDA	EUROS	REFERENCIA	MEDIDA	EUROS
AH690020	1/4"	1,20	AH690313	1/2"	0,79
AH690021	3/8"	1,05	AH690314	3/4"	1,02
AH690022	1/2"	0,66	AH690315	1"	1,72
AH690023	3/4"	0,93	AH690316	1 1/4"	3,25
AH690024	1"	1,43	AH690317	1 1/2"	4,43
AH690025	1 1/4"	2,63	AH690318	2"	6,32
AH690026	1 1/2"	3,08	AH690319	2 1/2"	20,37
AH690027	2"	5,19	AH690320	3"	30,24
AH690028	2 1/2"	17,58	AH690321	4"	40,61
AH690029	3"	26,89			
AH690030	4"	43,05			



**CURVA 90° ROSCA
MACHO-HEMBRA**



**CURVA 90° ROSCA
HEMBRA-HEMBRA**

REFERENCIA	MEDIDA	EUROS	REFERENCIA	MEDIDA	EUROS
AH690001	1/2"	2,10	AH690011	1/2"	1,93
AH690002	3/4"	3,08	AH690012	3/4"	3,04
AH690003	1"	4,10	AH690013	1"	4,39
AH690004	1 1/4"	7,80	AH690014	1 1/4"	7,86
AH690005	1 1/2"	9,95	AH690015	1 1/2"	9,99
AH690006	2"	19,96	AH690016	2"	17,72
AH690007	2 1/2"	39,42	AH690017	2 1/2"	41,20
AH690008	3"	55,01	AH690018	3"	54,08
AH690009	4"	91,34	AH690019	4"	93,73



**MANGUITO PARA CAÑA
ROSCA HEMBRA-HEMBRA
GALVANIZADO**

REFERENCIA	MEDIDA	EUROS
AH690150	3/4"	1,80

ACCESORIOS EN HIERRO GALVANIZADO

TUERCA DE REDUCCIÓN MACHO-HEMBRA

MACHÓN M/M REDUCIDO



REFERENCIA	MEDIDA	EUROS	REFERENCIA	MEDIDA	EUROS
AH690250	3/8" X 1/4"	1,02	AH691259	1/2" X 3/8"	1,38
AH690251	1/2" X 1/4"	0,69	AH691260	3/4" X 3/8"	2,16
AH690254	3/4" X 3/8"	0,84	AH691261	3/4" X 1/2"	1,15
AH690255	3/4" X 1/2"	0,55	AH691262	1" X 1/2"	2,50
AH690256	1" X 1/2"	1,08	AH691263	1" X 3/4"	1,46
AH690257	1" X 3/4"	1,08	AH691264	1 1/4" X 1/2"	4,51
AH690258	1 1/4" X 1/2"	1,82	AH691265	1 1/4" X 3/4"	3,54
AH690259	1 1/4" X 3/4"	1,79	AH691266	1 1/4" X 1"	2,58
AH690260	1 1/4" X 1"	1,51	AH691267	1 1/2" X 3/4"	3,75
AH690261	1 1/2" X 1/2"	2,32	AH691268	1 1/2" X 1"	5,42
AH690262	1 1/2" X 3/4"	2,47	AH691269	1 1/2" X 1 1/4"	4,07
AH690263	1 1/2" X 1"	1,99	AH691270	2" X 1"	5,76
AH690264	1 1/2" X 1 1/4"	1,94	AH691271	2" X 1 1/4"	7,20
AH690265	2" X 1/2"	5,06	AH691272	2" X 1 1/2"	6,49
AH690266	2" X 3/4"	4,90	AH691372	2 1/2" X 1"	14,06
AH690267	2" X 1"	3,69	AH691273	2 1/2" X 1 1/2"	14,06
AH690268	2" X 1 1/4"	3,46	AH691284	2 1/2" X 2"	14,06
AH690269	2" X 1 1/2"	3,46	AH691285	3" X 2"	22,36
AH690270	2 1/2" X 1/2"	15,50	AH691286	3" X 2 1/2"	22,36
AH960271	2 1/2" X 3/4"	15,50	AH691287	4" X 3"	70,57
AH690272	2 1/2" X 1"	10,60			
AH690273	2 1/2" X 1"1/4	10,60			
AH690274	2 1/2" X 1"1/2	10,77			
AH690275	2 1/2" X 2"	10,26			
AH690276	3" X 1"	12,17			
AH690278	3" X 1 1/4"	12,60			
AH690279	3" X 1 1/2"	11,90			
AH690999	3" X 2"	12,77			
AH690280	3" X 2 1/2"	12,85			
AH690281	4" X 2"	22,24			
AH690282	4" X 2 1/2"	22,68			
AH690283	4" X 3"	22,68			

ACCESORIOS EN HIERRO GALVANIZADO

MANGUITO DE REDUCCIÓN HEMBRA-HEMBRA



REFERENCIA	MEDIDA	EUROS
AH690202	1/2" X 3/8"	1,07
AH690203	3/4" X 3/8"	1,47
AH690204	3/4" X 1/2"	1,17
AH690205	1" X 1/2"	1,67
AH690206	1" X 3/4"	1,54
AH690207	1 1/4" X 1/2"	3,49
AH690208	1 1/4" X 3/4"	2,94
AH690209	1 1/4" X 1"	2,94
AH690210	1 1/2" X 1/2"	5,03
AH690211	1 1/2" X 3/4"	4,75
AH690212	1 1/2" X 1"	3,41
AH690213	1 1/2" X 1 1/4"	3,54
AH690214	2" X 1/2"	6,75
AH690215	2" X 3/4"	7,02
AH690216	2" X 1"	7,02
AH690217	2" X 1 1/4"	6,36
AH690218	2" X 1 1/2"	5,53
AH691219	2 1/2" X 1"	16,05
AH690219	2 1/2" X 1 1/4"	16,65
AH690220	2 1/2" X 1 1/2"	18,79
AH690221	2 1/2" X 2"	16,33
AH690222	3" X 1 1/2"	17,72
AH690223	3" X 2"	24,35
AH690224	3" X 2 1/2"	24,35
AH690225	4" X 2"	35,36
AH690226	4" X 2 1/2"	36,93
AH690227	4" X 3"	40,87

NIPPLES ROSCA MACHO-MACHO



MEDIDA	L-20 CM EUROS	L-25 CM EUROS	L-30 CM EUROS	L-40 CM EUROS	L-50 CM EUROS
3/8"	1,71	2,47	2,83	3,39	4,15
1/2"	1,69	2,32	2,94	3,25	3,95
3/4"	2,10	2,64	3,19	4,02	4,88
1"	2,89	3,84	4,80	5,97	7,25
1 1/4"	3,58	4,58	5,17	6,45	7,83
1 1/2"	4,04	5,53	6,10	7,62	9,26
2"	5,50	6,81	8,23	10,26	12,54
2 1/2"	8,12	9,42	10,36	14,37	17,03
3"	10,16	11,42	16,63	29,41	37,18
4"	16,17	19,00	21,00	44,76	51,80

ACCESORIOS EN HIERRO GALVANIZADO

TAPÓN REBORDE ROSCA MACHO



TAPÓN HEXAGONAL ROSCA HEMBRA

REFERENCIA	MEDIDA	EUROS	REFERENCIA	MEDIDA	EUROS
AH690081	1/4"	0,76	AH690404	1/2"	0,79
AH690082	3/8"	0,69	AH690405	3/4"	0,99
AH690083	1/2"	0,50	AH690406	1"	1,25
AH690084	3/4"	0,66	AH690407	1 1/4"	2,35
AH690085	1"	0,87	AH690408	1 1/2"	2,74
AH690086	1 1/4"	1,70	AH690409	2"	4,54
AH690087	1 1/2"	2,25	AH690410	2 1/2"	10,30
AH690088	2"	3,48	AH690411	3"	11,64
AH690089	2 1/2"	8,16	AH690412	4"	19,47
AH690090	3"	10,38			
AH690091	4"	17,12			

TUERCA UNIÓN HEMBRA JUNTA CÓNICA



TUERCA UNIÓN HEMBRA-MACHO JUNTA CÓNICA

REFERENCIA	MEDIDA	EUROS	REFERENCIA	MEDIDA	EUROS
AH690092	3/8"	4,61	AH690103	3/8"	4,61
AH690093	1/2"	3,91	AH690104	1/2"	4,38
AH690094	3/4"	4,80	AH690105	3/4"	5,63
AH690095	1"	5,79	AH690106	1"	6,94
AH690096	1 1/4"	8,24	AH690107	1 1/4"	9,39
AH690097	1 1/2"	10,07	AH690108	1 1/2"	12,73
AH690098	2"	15,08	AH690109	2"	17,90
AH690099	2 1/2"	35,28	AH690110	2 1/2"	45,25
AH690100	3"	51,96	AH690111	3"	73,21
AH690101	4"	100,38	AH690112	4"	113,71

ACCESORIOS EN HIERRO GALVANIZADO

MANGUITO M/H REDUCIDO



TE 90° REDUCIDA



REFERENCIA	MEDIDA	EUROS	REFERENCIA	MEDIDA	EUROS
AH690114	1/2" X 3/8"	1,78	AH690229	3/4" X 1/2"	1,40
AH690116	3/4" X 1/2"	1,54	AH690230	1" X 1/2"	2,09
AH690117	1" X 1/2"	2,19	AH690231	1" X 3/4"	2,30
AH690118	1" X 3/4"	2,19	AH690232	1 1/4" X 1/2"	4,01
AH690119	1 1/4" X 3/4"	4,10	AH690233	1 1/4" X 3/4"	4,41
AH691221	1 1/4" X 1"	4,10	AH690234	1 1/4" X 1"	4,62
AH691222	1 1/2" X 3/4"	5,50	AH690235	1 1/2" X 1/2"	5,50
AH691223	1 1/2" X 1"	5,50	AH690236	1 1/2" X 3/4"	5,68
AH691224	1 1/2" X 1 1/4"	6,68	AH690237	1 1/2" X 1"	5,50
AH691225	2" X 1"	7,96	AH690238	1 1/2" X 1 1/4"	8,66
AH691226	2" X 1 1/4"	7,17	AH690239	2" X 1/2"	7,55
AH691227	2" X 1 1/2"	7,85	AH690240	2" X 3/4"	10,57
			AH690241	2" X 1"	7,98
			AH690242	2" X 1 1/4"	10,57
			AH690243	2" X 1 1/2"	12,61
			AH690244	2 1/2" X 1"	27,43
			AH690245	2 1/2" X 1 1/2"	27,98
			AH690246	2 1/2" X 2"	31,97
			AH690247	3" X 1 1/2"	38,65
			AH690248	3" X 2"	35,15
			AH690249	3" X 2 1/2"	36,65
			AH690250	4" X 2"	63,60
			AH690251	4" X 2 1/2"	63,60
			AH690252	4" X 3"	63,60

MANGUITO M/H IGUAL



REFERENCIA	MEDIDA	EUROS
AH691253	1/2"	1,36
AH691254	3/4"	2,03
AH691255	1"	3,49
AH691256	1 1/4"	3,00
AH691257	1 1/2"	3,65
AH791258	2"	5,58

ENLACE RÓTULA ROSCA - MANGUERA



ROSCA	MANGUERA	EUROS
1"	30	24,71
1" 1/4	40 - 45	24,71
1" 1/2	50	24,71
2"	60	29,51
2" 1/2	70 - 75 - 80 - 90	45,90
3"	70 - 75 - 80 - 90	46,90
4"	110 - 114 - 120 - 125	68,90
5"	140 - 150	118,54
6"	200	CONSULTAR PRECIO

ROSCA - MANGUERA CURVA 90°



ROSCA	MANGUERA	EUROS
1"	30	34,81
1" 1/4	40 - 45	34,81
1" 1/2	50	35,50
2"	60	44,47
2" 1/2	70 - 75 - 80 - 90	64,98
3"	70 - 75 - 80 - 90	78,50
4"	110 - 114 - 120 - 125	130,00
5"	140 - 150	238,13
6"	200	266,29

MANGUERA - MANGUERA



MANGUERA	MANGUERA	EUROS
50	30 - 40 - 50 - 60	22,49
60	60	26,10
80	70 - 75 - 80 - 90	42,12
100	100 - 110 - 114 - 120 - 125	47,39
120	110 - 114 - 120 - 125	67,99
140	140 - 150	112,80
200	200	203,37
250	250	CONSULTAR PRECIO

ACCESORIOS PARA TUBERIA DE FUNDICIÓN DÚCTIL

ACCESORIOS CON JUNTA MECÁNICA

BRIDA ENCHUFE



DN	EUROS
80	50,00
100	56,00
125	71,00
150	73,00
200	113,00
250	172,00
300	234,00
350	286,00
400	340,00
450	462,00
500	655,00
600	926,00
700	1.779,00
800	2.284,00

MANGUITO UNIÓN



DN	EUROS
80	77,00
100	88,00
125	108,00
150	129,00
200	176,00
250	233,00
300	292,00
350	364,00
400	447,00
450	568,00
500	674,00
600	877,00
700	2.134,00
800	2.662,00

BRIDA LISO



DN	EUROS
80	37,00
100	46,00
125	59,00
150	75,00
200	107,00
250	154,00
300	209,00
350	315,00
400	390,00
450	483,00
500	659,00
600	957,00
700	1.918,00
800	2.331,00



CODO DOBLE ENCHUFE

DN	GRADOS	EUROS	GRADOS	EUROS	GRADOS	EUROS	GRADOS	EUROS
80	11,25°	71,00	22,5°	71,00	45°	71,00	90°	76,00
100	11,25°	83,00	22,5°	83,00	45°	83,00	90°	87,00
125	11,25°	107,00	22,5°	107,00	45°	107,00	90°	109,00
150	11,25°	125,00	22,5°	125,00	45°	125,00	90°	134,00
200	11,25°	174,00	22,5°	174,00	45°	174,00	90°	196,00
250	11,25°	287,00	22,5°	287,00	45°	287,00	90°	357,00
300	11,25°	421,00	22,5°	421,00	45°	421,00	90°	483,00
350	11,25°	564,00	22,5°	563,00	45°	563,00	90°	635,00
400	11,25°	577,00	22,5°	576,00	45°	576,00	90°	912,00
450	11,25°	706,00	22,5°	751,00	45°	859,00	90°	1.201,00
500	11,25°	790,00	22,5°	890,00	45°	1.010,00	90°	1.305,00
600	11,25°	1.162,00	22,5°	1.298,00	45°	1.534,00	90°	1.875,00
700	11,25°	2.675,00	22,5°	2.843,00	45°	3.257,00	90°	4.908,00
800	11,25°	3.439,00	22,5°	4.023,00	45°	4.370,00	90°	5.967,00

TAPÓN HEMBRA



DN	EUROS
80	46,00
100	54,00
125	67,00
150	85,00
200	129,00
250	176,00
300	247,00

ACCESORIOS PARA TUBERIA DE FUNDICIÓN DÚCTIL



REDUCCIÓN DOBLE ENCHUFE

DN	EUROS
100/80	95,00
125/100	112,00
150/100	132,00
200/100	168,00
200/150	179,00
250/150	223,00
250/200	224,00
300/150	310,00
300/200	317,00
300/250	324,00



TE TRES ENCHUFES

DN	EUROS
80/80	113,00
100/80	132,00
100/100	137,00
150/80	187,00
150/100	188,00
150/150	213,00
200/100	244,00
200/150	268,00
200/200	301,00

TE DOBLE ENCHUFE DERIVACIÓN BRIDA



DN	EUROS
80/40	74,00
80/65	77,00
80/80	83,00
100/80-60	103,00
100/100	110,00
125/80	121,00
125/100	128,00
125/125	138,00
150/80-60	142,00
150/100	153,00
150/125	174,00
150/150	174,00
200/80-60	189,00
200/100	199,00
200/150	228,00
200/200	249,00
250/80	282,00
250/100	282,00
250/150	286,00
250/200	321,00
250/250	362,00
300/80	486,00

DN	EUROS
300/100	486,00
300/150	486,00
300/200	486,00
300/250	486,00
300/300	486,00
350/80	567,00
350/100	567,00
350/150	567,00
350/200	622,00
350/250	683,00
350/300	735,00
350/350	795,00
400/80	664,00
400/100	664,00
400/150	720,00
400/200	819,00
400/250	889,00
400/300	958,00
400/400	1.039,00
450/100	782,00
450/150	892,00
450/200	909,00

DN	EUROS
450/250	1.089,00
450/300	1.129,00
450/450	1.408,00
500/100	1.163,00
500/150	1.163,00
500/200	1.163,00
500/250	1.163,00
500/300	1.309,00
500/500	1.699,36
600/100	1.623,00
600/150	1.623,00
600/200	1.623,00
600/250	1.623,00
600/300	1.746,00
600/400	1.865,00
600/600	2.465,00
700/150-200	3.862,00
700/250-300	4.025,00
700/500-700	5.031,00
800/250-400	5.414,00
800/600-500	6.491,00
800/800	6.767,00



ACCESORIOS CON BRIDA CODO BRIDA - BRIDA

DN	GRADOS	EUROS	GRADOS	EUROS	GRADOS	EUROS	GRADOS	EUROS
65	11,25°	47,00	22,5°	47,00	45°	47,00	90°	47,00
80	11,25°	49,00	22,5°	49,00	45°	49,00	90°	50,00
100	11,25°	59,00	22,5°	60,00	45°	59,00	90°	60,00
125	11,25°	74,00	22,5°	74,00	45°	74,00	90°	75,00
150	11,25°	95,00	22,5°	94,00	45°	94,00	90°	95,00
200	11,25°	155,00	22,5°	155,00	45°	154,00	90°	170,00
250	11,25°	320,00	22,5°	320,00	45°	307,00	90°	307,00
300	11,25°	399,00	22,5°	399,00	45°	382,00	90°	466,00
350	11,25°	481,00	22,5°	480,00	45°	592,00	90°	703,00
400	11,25°	620,00	22,5°	625,00	45°	649,00	90°	834,00
450	11,25°	721,00	22,5°	843,00	45°	1.001,00	90°	1.295,00
500	11,25°	994,00	22,5°	993,00	45°	1.150,00	90°	1.465,00
600	11,25°	1.540,00	22,5°	1.540,00	45°	1.750,00	90°	2.240,00
700	11,25°	3.030,00	22,5°	3.012,00	45°	3.155,00	90°	4.128,00
800	11,25°	3.535,00	22,5°	3.814,00	45°	4.222,00	90°	5.645,00



CARRETE DOBLE BRIDA

DN	EUROS
65/250	52,00
65/500	73,00
80/100	41,00
80/150	43,00
80/200	48,00
80/250	47,00
80/300	52,00
80/400	59,00
80/500	65,00
80/600	91,00
80/800	100,00
80/1000	129,00
100/100	48,00
100/150	49,00
100/200	52,00

DN	EUROS
100/250	54,00
100/300	60,00
100/400	68,00
100/500	75,00
100/600	115,00
100/800	121,00
100/1000	163,00
125/250	86,00
125/500	102,00
150/150	73,00
150/200	81,00
150/250	87,00
150/300	94,00
150/400	108,00
150/500	122,00

DN	EUROS
150/1000	200,00
200/150	128,00
200/200	131,00
200/250	134,00
200/300	165,00
200/400	171,00
200/500	178,00
200/1000	332,00
250/250	170,00
250/500	256,00
300/250	313,00
300/500	343,00
350/500	599,00
400/500	769,00
500/500	1.259,00
600/500	1.621,00

BRIDAS REDUCTORAS



MEDIDAS	EUROS	MEDIDAS	EUROS	MEDIDAS	EUROS
65-50	35,00	150-65	53,00	250-100	136,00
80-50	36,00	150-80	67,00	250-125	140,00
80-65	37,00	150-100	68,00	250-150	144,00
100-50	40,00	150-125	65,00	300-100	146,00
100-65	42,00	200-80	85,00	300-125	152,00
100-80	53,00	200-100	89,00	300-150	154,00
125-65	46,00	200-125	88,00	300-200	162,00
125-80	58,00	200-150	88,00	300-250	168,00
125-100	57,00	250-80	134,00	ESPARRAGO	1,30

ACCESORIOS PARA TUBERIA DE FUNDICIÓN DÚCTIL

ACCESORIO CON BRIDA

REDUCCIÓN DOBLE BRIDA



DN	EUROS	DN	EUROS	DN	EUROS
60/50	47,00	200/100	84,00	400/200	425,00
80/50	37,00	200/125	92,00	400/250	419,00
80/65	49,00	200/150	102,00	400/300	462,00
100/50	40,00	250/100	150,00	400/350	519,00
100/65	47,00	250/150	155,00	450/300-350	748,00
100/80	43,00	250/200	169,00	450/400	748,00
125/80	56,00	300/100	307,00	500/300-400	920,00
125/100	55,00	300/150	307,00	500/450-350	920,00
150/80-65	59,00	300/200	307,00	600/400	1.170,00
150/100	63,00	300/250	322,00	600/500-450	1.329,00
150/125	70,00	350/200	343,00	700/500-600	2.219,00
200/80	82,00	350/250	385,00	800/500-600	2.994,00
		350/300	449,00	800/700	3.078,00

TE 3 BRIDAS



DN	EUROS	DN	EUROS	DN	EUROS
60/60	71,00	250/150	427,00	450/200	1.261,00
65/65	78,00	250/200	432,00	450/250	1.288,00
80/60	76,00	250/250	448,00	450/300	1.315,00
80/65	86,00	300/80	507,00	450/450	1.465,00
80/80	71,00	300/100	514,00	500/100	1.385,00
100/60	90,00	300/150	550,00	500/150	1.405,00
100/65	100,00	300/200	558,00	500/200	1.428,00
100/80	84,00	300/250	603,00	500/250	1.453,00
100/100	87,00	300/300	599,00	500/300	1.487,00
125/80	103,00	350/80	778,00	500/500	1.895,00
125/100	107,00	350/100	807,00	600/100	1.986,00
125/125	113,00	350/150	838,00	600/150	2.016,00
150/60	139,00	350/200	866,00	600/200	2.039,00
150/65	149,00	350/250	889,00	600/250	2.070,00
150/80	130,00	350/300	922,00	600/300	2.101,00
150/100	132,00	350/350	930,00	600/400	2.196,00
150/125	163,00	400/80	924,00	600/600	2.780,00
150/150	158,00	400/100	959,00	700/150-200	2.882,00
200/80	187,00	400/150	976,00	700/250-300	3.650,00
200/100	189,00	400/200	1.000,00	700/500	4.950,00
200/125	199,00	400/250	1.026,00	700/700	5.091,00
200/150	233,00	400/300	1.060,00	800/150-200	3.774,00
200/200	245,00	400/400	1.144,00	800/250-300	4.664,00
250/80	382,00	450/100	1.214,00	800/400	4.691,00
250/100	381,00	450/150	1.238,00	800/600	6.596,00
				800/800	6.922,00



CRUZ BRIDAS

DN	EUROS
80/80	93,00
100/100	117,00
125/125	216,00
150/150	209,00
200/200	318,00
250/250	646,00
300/300	913,00

ACCESORIOS ELECTROSOLDABLES

CODO ELECTROSOLDABLE 90°



REFERENCIA	MEDIDA	EUROS
AES0000025	25	9,74
AES0000032	32	9,97
AES0000040	40	12,55
AES0000050	50	16,14
AES0000063	63	18,67
AES0000075	75	27,37
AES0000090	90	31,18
AES0000110	110	44,98
AES0000125	125	62,37
AES0000140	140	94,43
AES0000160	160	94,80
AES0000200	200	313,11

CODO ELECTROSOLDABLE 45°



REFERENCIA	MEDIDA	EUROS
AES1000032	32	10,50
AES1000040	40	12,79
AES1000050	50	16,25
AES1000063	63	18,77
AES1000075	75	28,20
AES1000090	90	32,42
AES1000110	110	48,84
AES1000125	125	66,82
AES1000140	140	94,43
AES1000160	160	95,20
AES1000200	200	313,11

ACCESORIOS ELECTROSOLDABLES

TE IGUAL ELECTROSOLDABLE



REFERENCIA	MEDIDA	EUROS
AES20000025	25	15,17
AES20000032	32	15,17
AES20000040	40	15,86
AES20000050	50	16,81
AES20000063	63	19,67
AES20000075	75	31,27
AES20000090	90	32,28
AES20000110	110	52,92
AES20000125	125	68,12
AES20000160	160	111,36

MANGUITO TRANSICIÓN ELECTROSOLDABLE ROSCA MACHO



REFERENCIA	MEDIDA	EUROS
AES116110020	20 x 1/2"	22,40
AES116110025	25 x 3/4"	25,63
AES116110032	32 x 1"	28,19
AES116110040	40 x 1 1/4"	41,50
AES116110050	50 x 1 1/2"	57,19
AES116110063	63 x 2"	64,56

MANGUITO TRANSICIÓN ELECTROSOLDABLE ROSCA HEMBRA



REFERENCIA	MEDIDA	EUROS
AES126110020	20 x 1/2"	25,35
AES126110025	25 x 3/4"	27,88
AES126110032	32 x 1"	34,24
AES126110040	40 x 1 1/4"	42,10
AES126110050	50 x 1 1/2"	58,20
AES126110063	63 x 2"	65,86

ACCESORIOS ELECTROSOLDABLES

MANGUITO ELECTROSOLDABLE



REFERENCIA	MEDIDA	EUROS
AES 111010020	20	3,83
AES 111010025	25	4,04
AES 111010032	32	4,14
AES 111010040	40	4,24
AES 111010050	50	6,06
AES 111010063	63	6,52
AES 111010075	75	10,66
AES 111010090	90	12,44
AES 111010110	110	14,63
AES 111010125	125	24,13
AES 111010140	140	36,50
AES 111010160	160	28,40
AES 111010180	180	43,30
AES 111010200	200	49,14
AES 111010225	225	90,36
AES 111010250	250	91,23
AES 111010315	315	182,87
AES 111010400	400	462,69
AES 111010500	500	1.262,14

ACCESORIOS DE P.E.A.D. PARA SOLDADURA A TOPE

TAPÓN P.E.A.D.



REFERENCIA	MEDIDA	EUROS
AES103510025	25	3,49
AES103510032	32	3,77
AES103510040	40	4,72
AES103510050	50	5,58
AES103510063	63	7,43
AES103510075	75	10,59
AES103510090	90	16,47
AES103510110	110	22,19
AES103510125	125	24,24
AES103510140	140	38,22
AES103510160	160	39,78
AES103510180	180	44,70
AES103510200	200	56,30
AES103510225	225	75,31
AES103510250	250	98,44
AES103510315	315	174,60

ACCESORIOS DE P.E.A.D. PARA SOLDADURA A TOPE PORTABRIDA P.E.A.D.



REFERENCIA	MEDIDA	EUROS
AES103010025	25	3,31
AES103010032	32	3,88
AES103010040	40	4,60
AES103010050	50	5,24
AES103010063	63	6,39
AES103010075	75	7,97
AES103010090	90	10,28
AES103010110	110	12,70
AES103010125	125	15,52
AES103010140	140	19,87
AES103010160	160	26,84
AES103010180	180	37,81
AES103010200	200	38,96
AES103010225	225	45,92
AES103010250	250	60,39
AES103010280	280	141,90
AES103010315	315	172,54
AES103010355	355	232,30
AES103010400	400	451,27

CODO P.E.A.D. 90° SOLDADURA A TOPE



REFERENCIA	MEDIDA	EUROS
AES101010025	25	3,60
AES101010032	32	4,03
AES101010040	40	4,55
AES101010050	50	6,07
AES101010063	63	9,44
AES101010075	75	12,90
AES101010090	90	15,58
AES101010110	110	26,91
AES101010125	125	44,00
AES101010140	140	52,79
AES101010160	160	54,57
AES101010180	180	75,44
AES101010200	200	103,47
AES101010225	225	109,71
AES101010250	250	207,87
AES101010315	315	352,62

CODO P.E.A.D. 45° SOLDADURA A TOPE



REFERENCIA	MEDIDA	EUROS
AES101010032	32	4,03
AES101010040	40	4,55
AES101010050	50	6,07
AES101010063	63	9,44
AES101010075	75	12,90
AES101010090	90	15,58
AES101010110	110	26,91
AES101010125	125	44,00
AES101010140	140	52,79
AES101010160	160	54,57
AES101010180	180	75,44
AES101010200	200	103,47
AES101010225	225	114,23
AES101010250	250	207,87
AES101011315	315	320,00

ACCESORIOS DE P.E.A.D. PARA SOLDADURA A TOPE REDUCCIÓN P.E.A.D.



REFERENCIA	MEDIDA	EUROS
AES105002520	25x20	3,53
AES105003220	32x20	3,79
AES105003225	32x25	3,79
AES105004020	40x20	4,71
AES105004025	40x25	4,71
AES105004032	40x32	4,71
AES105005025	50x25	5,04
AES105005032	50x32	5,04
AES105005040	50x40	5,04
AES105006332	63x32	6,71
AES105006340	63x40	6,71
AES105006350	63x50	6,71
AES105007550	75x50	9,87
AES105007563	75x63	9,87
AES105009050	90x50	11,03
AES105009063	90x63	13,27
AES105009075	90x75	13,27
AES105011063	110x63	17,71
AES105011075	110x75	21,48
AES105011090	110x90	21,60
AES105012563	125x63	23,04
AES105012590	125x90	20,50
AES105012511	125x110	22,20
AES105014090	140x90	44,64
AES105014011	140x110	46,08
AES105014012	140x125	33,92
AES105016090	160x90	38,33
AES105016011	160x110	33,84
AES105016012	160x125	38,30
AES105016014	160x140	46,59
AES105018012	180x125	57,60
AES105018014	180x140	56,70
AES105018016	180x160	57,60
AES105020014	200x140	68,91
AES105020016	200x160	50,80
AES105020018	200x180	73,75
AES105022516	225x160	98,03
AES105022518	225x180	98,03
AES105022520	225x200	98,03
AES105025016	250x160	132,04
AES105025018	250x180	132,04
AES105025020	250x200	132,04
AES105025022	250x225	132,04
AES105031522	315x225	241,86
AES105031525	315x250	212,02
AES105035525	355x250	Consultar precio
AES105035528	355x280	Consultar precio
AES105035531	355x315	Consultar precio
AES105040028	400x280	Consultar precio
AES105040031	400x315	Consultar precio
AES105040035	400x355	Consultar precio

ACCESORIOS DE P.E.A.D. PARA SOLDADURA A TOPE

TE P.E.A.D.



REFERENCIA	MEDIDA	EUROS
AES102010025	25	4,35
AES102010032	32	4,95
AES102010040	40	6,04
AES102010050	50	8,64
AES102010063	63	9,84
AES102010075	75	16,56
AES102010090	90	23,15
AES102010110	110	30,40
AES102010125	125	52,01
AES102010140	140	72,23
AES102010160	160	83,86
AES102010180	180	133,28
AES102010200	200	153,84
AES102010225	225	237,24
AES102010250	250	288,30
AES102010315	315	458,86
AES102010355	355	931,63
AES102010400	400	1.476,60

TE P.E.A.D. REDUCIDA



REFERENCIA	MEDIDA	EUROS
AES102106350	63x50	20,67
AES102107550	75x50	32,37
AES102107563	75x63	32,37
AES102109050	90x50	38,50
AES102109063	90x63	38,50
AES102109075	90x75	38,50
AES102111063	110x63	43,90
AES102111075	110x75	51,81
AES102111090	110x90	44,64
AES102112511	125x110	94,52
AES102116011	160x110	118,33
AES102118016	180x125	258,33
AES102120016	200x160	390,64
AES102125020	250x200	481,60
AES102125022	250x225	481,60
AES102131525	315x250	825,23

BRIDAS ACERO REBAJADAS Y ZINCADAS PARA PORTABRIDAS DE P.E.

NORMAS DIN 2576 PN-10

NORMAS DIN 2702 PN-16



REFERENCIA	MEDIDA	EUROS	REFERENCIA	MEDIDA	EUROS
BP910050	50-50	8,55	BP916080	90 PN-16	14,44
BP910150	50-63	8,55	BP916200	200 PN-16	33,12
BP910065	65-63	11,05	BP916250	250 PN-16	47,20
BP910165	65-75	11,05	BP916300	315 PN-16	60,92
BP910080	80-90	14,44	BP916400	400 PN-16	117,66
BP910100	100-110	15,31	BP916500	500 PN-16	205,38
BP910125	125-125	21,14			
BP911125	125-140	21,14			
BP910160	150-160	22,86			
BP910200	200 PN10	33,12			
BP910250	250 PN-10	44,43			
BP910300	315 PN-10	60,92			
BP910400	400 PN-10	117,66			

BRIDAS PLANAS PARA SOLDAR NORMAS DIN 2576 PN-10

BRIDAS PLANAS PARA SOLDAR NORMAS DIN 2502 PN-16



REFERENCIA	MEDIDA	EUROS	REFERENCIA	MEDIDA	EUROS
BP911021	15	4,06	BP913015	15	4,06
BP911022	20	4,06	BP913020	20	4,06
BP911023	25	4,17	BP913025	25	4,17
BP911024	32	6,11	BP913032	32	6,11
BP911025	40	6,98	BP913040	40	6,98
BP911026	50	8,77	BP913050	50	8,77
BP911027	65	10,65	BP913065	65	10,65
BP911028	80	13,82	BP913080	80	13,82
BP911029	100	15,67	BP913100	100	15,67
BP911030	125	19,67	BP913125	125	19,67
BP911031	150	26,7	BP913150	150	26,70
BP911033	200	35,84	BP913200	200	33,12
BP911034	250	42,29	BP913250	250	52,98
BP911035	300	54,11	BP913300	300	69,36
BP911036	350	79,83	BP913350	350	84,96
BP911037	400	109,87	BP913400	400	113,63
BP911038	450	142,24	BP913450	450	149,08
BP911039	500	177,78	BP913500	500	187,85
BP911040	600	209,95	BP913600	600	302,09
BP911141	700	273,06	BP913700	700	317,69
BP911142	800	376,45	BP913800	800	438,28
BP911143	900	587,53	BP913900	900	677,04
BP911144	1000	731,62	BP913110	1000	961,40

**BRIDA ACERO ZINCADAS
PORTABRIDAS PVC TIPO RIEGO**

**BRIDA SOLDAR
TIPO RIEGO**



REFERENCIA	MEDIDA	EUROS	REFERENCIA	MEDIDA	EUROS
BP912050	50-50	7,11	BP915002	50	6,67
BP912150	50-63	7,11	BP915003	65	8,10
BP912063	65-63	8,52	BP915004	80 PN-10	9,22
BP912075	65-75	8,52	BP915014	80 PN-16	9,22
BP912090	80-90	9,62	BP915005	100	9,84
BP912110	100-110	10,31	BP915006	125	12,08
BP912125	125-125	12,90	BP915007	150	16,97
BP912140	125-140	12,90	BP915008	200	22,29
BP912160	150-160	16,10	BP915009	250	26,33
BP912200	200-200	23,02	BP915010	300	30,46
BP912250	250-250	28,71			
BP912315	300-315	38,61			
BP912400	400-400	59,60			

BRIDAS PLANAS CIEGAS NORMAS DIN 2527 PN-10 **BRIDAS PLANAS CIEGAS NORMAS DIN 2527 PN-16**



REFERENCIA	MEDIDA	EUROS	REFERENCIA	MEDIDA	EUROS
BP911041	15	4,26	BP914000	80	17,30
BP911043	20	4,32	BP914002	200	59,97
BP911044	25	4,49	BP914003	250	92,20
BP911045	32	6,73	BP914004	300	109,84
BP911046	40	7,76	BP914005	350	180,00
BP911047	50	10,57	BP914006	400	232,70
BP911048	65	14,27	BP914007	450	278,76
BP911049	80	17,30	BP914008	500	419,93
BP911050	100	20,92	BP914009	600	558,67
BP911051	125	28,41			
BP911052	150	38,37			
BP911054	200	59,97			
BP911155	250	87,29			
BP911156	300	110,79			
BP911157	350	143,75			
BP911158	400	178,87			
BP911159	500	271,77			
BP911160	600	368,38			

BRIDAS PLANAS ROSCADAS NORMAS DIN 2502 PN-10/16 **BRIDAS BISELADAS PARA PVC**



REFERENCIA	MEDIDA	EUROS	REFERENCIA	MEDIDA	EUROS
BP911055	25 - 1"	6,80	BP916001	63	4,93
BP911056	32 - 1 1/4"	8,10	BP916002	75	6,92
BP911057	40 - 1 1/2"	8,94	BP916003	90	8,66
BP911058	50 - 2" - 1 1/2"	11,44	BP916004	110	9,73
BP911059	65 - 2 1/2" - 2"	14,02	BP916005	125	10,61
BP911060	80 - 3" - 2 1/2" - 2"	17,76	BP916006	140	11,89
BP911061	100 - 4" - 3" - 2 1/2" - 2"	18,84	BP916007	160	12,95
BP911062	125 - 5"	24,23	BP916008	180	12,79
			BP916009	200	14,16
			BP916010	250	17,72
			BP916011	315	21,82
			BP916012	400	29,81
			BP916013	500	49,36
			BP916014	630	78,96

* OTRAS MEDIDAS O ROSCAS
CONSULTAR



TE PVC

REFERENCIA	MEDIDA	EUROS
APE01075	20	0,46
APE01025	25	0,60
APE01026	32	0,86
APE01027	40	1,40
APE01028	50	1,99
APE01029	63	2,80
APE01030	75	5,95
APE01031	90	10,70
APE01032	110	15,91
APE01033	125	26,23
APE01034	140	39,90
APE01035	160	47,12
APE01036	200	68,04
APE01094	225	106,89
APE01095	250	217,55
APE01096	315	505,05
APE01400	400	CONSULTAR PRECIOS



TE REDUCIDA PVC

REFERENCIA	MEDIDA	EUROS
APE01201	25/20	0,62
APE01209	32/20	0,96
APE01202	32/25	0,96
APE01210	40/20	1,49
APE01211	40/25	1,49
APE01203	40/32	1,49
APE01213	50/25	2,09
APE01214	50/32	2,09
APE01204	50/40	2,09
APE01217	63/32	2,96
APE01218	63/40	2,96
APE01205	63/50	2,96
APE01219	75/32	5,98
APE01220	75/40	5,98
APE01221	75/50	5,98
APE01206	75/63	5,98
APE01222	90/40	10,71
APE01223	90/50	10,71
APE01224	90/63	10,71
APE01207	90/75	10,71
APE01225	110/50	15,89
APE01226	110/63	15,89
APE01227	110/75	15,89
APE01208	110/90	15,89
APE01228	125/63	26,24
APE01229	125/75	26,24
APE01230	125/90	26,24
APE01231	125/110	26,24
APE01232	140/75	39,91
APE01233	140/90	39,91
APE01234	140/110	39,91
APE01235	140/125	39,91
APE01236	160/90	46,79
APE01237	160/110	46,79
APE01238	160/125	46,79
APE01239	160/140	46,79
APE01240	200/110	75,61
APE01241	200/125	75,61
APE11242	200/140	75,61
APE11243	200/160	75,61



MANGUITO PVC

REFERENCIA	MEDIDA	EUROS
APE01076	20	0,43
APE01037	25	0,49
APE01038	32	0,59
APE01039	40	0,85
APE01040	50	1,15
APE01041	63	1,68
APE01042	75	3,49
APE01043	90	4,46
APE01044	110	7,42
APE01045	125	11,48
APE01046	140	17,02
APE01047	160	23,10
APE01048	200	34,99
APE01097	225	72,32
APE01098	250	108,35
APE01099	315	191,40
APE01100	400	CONSULTAR PRECIOS

ACCESORIOS PRESIÓN ENCOLAR PVC

CODO 90° PVC



REFERENCIA	MEDIDA	EUROS
APE01074	20	0,37
APE01001	25	0,47
APE01002	32	0,69
APE01003	40	0,97
APE01004	50	1,48
APE01005	63	2,23
APE01006	75	4,10
APE01007	90	6,66
APE01008	110	12,41
APE01009	125	18,62
APE01010	140	31,95
APE01011	160	37,30
APE01012	200	54,81
APE01091	225	99,38
APE01092	250	192,68
APE01093	315	431,32
APE01401	400	CONSULTAR PRECIOS

CODO 45° PVC



REFERENCIA	MEDIDA	EUROS
APE01073	20	0,49
APE01013	25	0,68
APE01014	32	0,89
APE01015	40	1,19
APE01016	50	1,62
APE01017	63	2,39
APE01018	75	4,37
APE01019	90	6,79
APE01020	110	11,50
APE01021	125	16,55
APE01022	140	26,82
APE01023	160	32,63
APE01024	200	48,43
APE01088	225	89,10
APE01089	250	156,17
APE01090	315	281,98
APE01402	400	CONSULTAR PRECIOS

CASQUILLO REDUCTOR PVC



REFERENCIA	MEDIDA	EUROS
APE01061	25/20	0,29
APE01062	32/25	0,32
APE01063	40/32	0,49
APE01064	50/40	0,60
APE01065	63/50	0,85
APE01066	75/63	1,52
APE01067	90/75	2,52
APE01068	110/90	4,62
APE01069	125/110	6,32
APE01070	140/125	8,58
APE01071	160/140	11,35
APE01072	200/160	24,57
APE01072	200/160	36,47
APE01173	225/200	49,00
APE01101	250/200	85,28
APE01102	315/250	132,00
APE01077	400/315	CONSULTAR PRECIOS

TAPÓN HEMBRA ENCOLAR PVC



REFERENCIA	MEDIDA	EUROS
APE010048	20	0,32
APE01049	25	0,40
APE01050	32	0,50
APE01051	40	0,76
APE01052	50	1,20
APE01053	63	1,64
APE01054	75	3,13
APE01055	90	4,95
APE01056	110	10,36
APE01057	125	14,25
APE01058	140	18,49
APE01059	160	22,08
APE01060	200	27,07
APE010061	250	93,18
APE010062	315	142,87

TAPÓN ROSCA MACHO PVC



REFERENCIA	MEDIDA	EUROS
APE02019	1/2"	0,50
APE02020	3/4"	0,64
APE02021	1"	0,86
APE02022	1 1/4"	1,10
APE02023	1 1/2"	1,48
APE02024	2"	1,75
APE02025	2 1/2"	2,97
APE02026	3"	4,80
APE02027	4"	9,14

TAPÓN ROSCA HEMBRA PVC



REFERENCIA	MEDIDA	EUROS
APE10053	1/2"	0,74
APE10054	3/4"	0,79
APE10055	1"	0,99
APE10056	1 1/4"	1,40
APE10057	1 1/2"	1,85
APE10058	2"	2,47
APE10059	2 1/2"	5,64
APE10060	3"	9,17
APE10061	4"	12,85

MANGUITO UNIÓN MIXTO ENCOLAR Y ROSCAR PVC



REFERENCIA	MEDIDA	EUROS
APE02010	20 - 1/2"	0,80
APE02011	25 - 3/4"	0,93
APE02012	32 - 1"	1,04
APE02013	40 - 1 1/4"	1,32
APE02014	50 - 1 1/2"	1,59
APE02015	63 - 2"	2,38
APE02016	75 - 2 1/2"	4,42
APE02017	90 - 3"	8,18
APE02018	110 - 4"	11,64

TERMINAL ROSCA MACHO ENCOLAR Y ROSCAR PVC



REFERENCIA	MEDIDA	EUROS
APE02001	20 - 1/2"	0,55
APE02002	25 - 3/4"	0,64
APE02003	32 - 1"	0,74
APE02004	40 - 1 1/4"	0,99
APE02005	50 - 1 1/2"	1,19
APE02006	63 - 2"	1,87
APE02007	75 - 2 1/2"	3,42
APE02008	90 - 3"	6,56
APE02009	110 - 4"	10,62

ENLACE TRES PIEZAS ENCOLAR PVC



REFERENCIA	MEDIDA	EUROS
APE01079	20	1,35
APE01080	25	1,56
APE01081	32	2,29
APE01082	40	2,74
APE01083	50	3,53
APE01084	63	5,16
APE01085	75	15,18
APE01086	90	20,45
APE01087	110	27,69

ENLACE TRES PIEZAS MIXTO ENCOLAR Y ROSCAR HEMBRA PVC

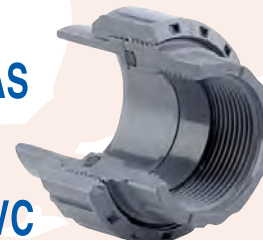

REFERENCIA	MEDIDA	EUROS
APE02028	20 - 1/2"	1,51
APE02029	25 - 3/4"	1,73
APE02030	32 - 1"	2,45
APE02031	40 - 1 1/4"	3,02
APE02032	50 - 1 1/2"	3,92
APE02033	63 - 2"	5,61
APE02034	75 - 2 1/2"	16,22
APE02035	90 - 3"	21,85
APE02036	110 - 4"	29,75

ACCESORIOS PRESIÓN ENCOLAR PVC



**ENLACE TRES PIEZAS
ENCOLAR Y ROSCA
MACHO PVC**

REFERENCIA	MEDIDA	EUROS
APMH002	32 - 1"	2,46
APMH003	40 - 1 1/4"	3,14
APMH004	50 - 1 1/2"	3,65
APMH005	63 - 2"	5,90
APMH006	75 - 2 1/2"	18,45



**CRUZ 90°
PVC**

REFERENCIA	MEDIDA	EUROS
APE11241	20	1,02
APE10242	25	1,27
APE10243	32	1,72
APE10244	40	2,92
APE10245	50	4,02
APE10246	63	5,69
APE10247	75	8,98
APE10248	90	29,24
APE10249	110	47,20
APE10250	125	55,40
APE10251	160	80,37
APE10252	200	116,41



**PORTABRIDA
PLANO PVC**

REFERENCIA	MEDIDA	EUROS
APE10130	50	1,62
APE10131	63	1,92
APE10132	75	2,62
APE10133	90	4,01
APE10134	110	5,00
APE10135	125	6,24
APE10136	140	8,80
APE10137	160	12,18
APE10138	200	22,40
APE10139	225	26,43
APE10140	250	60,80
APE10141	315	93,98
APE01403	400	CONSULTAR PRECIOS

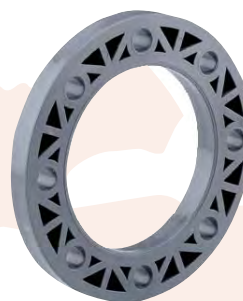

**BRIDA
PLANA PVC**

REFERENCIA	MEDIDA	EUROS
APE10025	50	3,57
APE10026	63	3,74
APE10027	75	4,50
APE10028	90	4,98
APE10029	110	6,98
APE10030	125	10,19
APE10031	140	11,58
APE10032	160	13,95
APE10033	200	16,95
APE10034	225	30,81
APE10128	250	54,09
APE10129	315	83,32

ACCESORIOS PRESIÓN ENCOLAR PVC BRIDA COMPACTA SALIDA ENCOLAR PVC



REFERENCIA	MEDIDA	EUROS
APE10045	50	6,33
APE10046	63	7,54
APE10047	75	8,58
APE10048	90	9,89
APE10049	110	12,53
APE10050	125	15,08
APE10051	140	18,22
APE10052	160	24,53

REDUCCIÓN CÓNICA PVC



REFERENCIA	MEDIDA	EUROS
APE01078	32-25-20	0,50
APE01103	40-32-25	0,71
APE01104	50-40-32	1,00
APE01105	63-50-40	1,58
APE01106	75-63-50	2,46
APE01107	90-75-63	3,20
APE01108	110-90-75	5,54
APE01109	125-110-90	7,86
APE01110	140-125-110	10,29
APE01111	160-140-125	15,34
APE01112	200-160	32,00

MANGUITO NETVIC PVC



REFERENCIA	MEDIDA	EUROS
APE10N17	63-75	4,67
APE10N19	90-110	10,46
APE10N20	110-125	14,10
APE10N21	160	34,01

BRIDA NETVIC PVC



REFERENCIA	MEDIDA	EUROS
APE10N32	63	12,08
APE10N33	75	14,06
APE10N34	90	16,62
APE10N35	110	27,22
APE10N36	160	51,71

VÁLVULA MODULAR DE PIE NETWELL PVC

DESCARGA CON SALIDA ROSCA HEMBRA



REFERENCIA	MEDIDA	EUROS
APE14006	2 1/2"	96,64
APE14007	3"	100,36
APE14008	4"	114,03

DESCARGA CON SALIDA ENCOLAR



REFERENCIA	MEDIDA	EUROS
APE14026	90	115,41
APE14027	110	132,77
APE14028	125	153,00
APE14029	140	309,00
APE14030	160	338,50
APE14052	200	412,10

DESCARGA CON SALIDA NETVIC



REFERENCIA	MEDIDA	EUROS
APE14047	90	102,42
APE14048	110	116,09

VÁLVULA DE MARIPOSA PVC

VÁLVULA DE MARIPOSA IMPLEX CON BRIDAS



REFERENCIA	MEDIDA	EUROS
VMP09042	63	80,79
VMP09043	75	87,14
VMP09044	90	121,63
VMP09045	110	139,18
VMP09046	125	163,51
VMP09047	140	182,17
VMP09048	160	241,62
VMP09049	200/225	342,14
VMP09050	250	674,30

VÁLVULA DE MARIPOSA IMPLEX



REFERENCIA	MEDIDA	EUROS
VMP09029	63	67,45
VMP090129	75	70,14
VMP09030	90	79,83
VMP09031	110	87,83
VMP09032	125	100,72
VMP09033	140	103,77
VMP09034	160	119,75
VMP09035	200/225	172,79
VMP09036	250	331,84

FILTRO ANILLAS SALIDA BRIDAS



REFERENCIA	MEDIDA	EUROS
FYP08003	63 - 2"	198,86
FYP08004	90 - 3"	248,58

FILTRO ANILLAS SALIDA ROSCADA



REFERENCIA	MEDIDA	EUROS
FYP08001	63 - 2"	159,07
FYP08002	90 - 3"	208,79

DESPIECE FILTRO ANILLAS



REFERENCIA	MEDIDA	EUROS
FYP08009	63 - 2"	78,55
FYP08010	90 - 3"	104,35

VÁLVULA RETENCIÓN DE PVC VÁLVULA RETENCIÓN "SYSTEM"



REFERENCIA	MEDIDA	EUROS
VMP13002	90	109,62
VMP13003	110	122,49
VMP13004	125	143,74
VMP13005	140	170,09
VMP13006	160	215,65
VMP13007	200	287,51
VMP13019	250	441,03
VMP13119	315	548,42

VÁLVULA DE RETENCIÓN CON MECANISMO AUTO/CIERRE "SYSTEM"



REFERENCIA	MEDIDA	EUROS
VMP13012	90	131,78
VMP13013	110	146,74
VMP13014	125	171,58
VMP13015	140	203,66
VMP13016	160	251,58
VMP13017	200	328,87
VMP13018	250	489,02
VMP13118	315	597,11

VÁLVULA DE RETENCIÓN CON MECANISMO Y VISOR ABIERTA/CERRADA "SYSTEM"



REFERENCIA	MEDIDA	EUROS
VMP13022	90	155,76
VMP13023	110	169,51
VMP13024	125	195,53
VMP13025	140	239,61
VMP13026	160	287,51
VMP13008	200	366,00
VMP13020	250	543,68
VMP13120	315	651,79

MASILLA ANTICORROSIVA E IMPERMEABILIZANTE PARA UNIONES ROSCADAS

COLA PARA PVC



REFERENCIA	KGS	EUROS
BT13009	400 GR	4,89
BT13019	150 GR	3,10

REFERENCIA	KGS	EUROS
BT13010	1	16,00

LUBRICANTE PARA PVC

DISOLVENTE PARA PVC

REFERENCIA	LITROS	EUROS
PASTA	5	9,03

REFERENCIA	KGS	EUROS
BT13012	1	9,03

ACCESORIOS PARA POLIETILENO / FITTING

ENLACE RECTO



REFERENCIA	MEDIDA	EUROS
APH12019	20	1,72
APH12020	25	2,03
APH12021	32	2,87
APH12022	40	4,51
APH12023	50	6,29
APH12024	63	9,55
APH12025	75	17,61
APH12026	90	29,25
APH12027	110	40,37

ENLACE RECTO REDUCIDO



REFERENCIA	MEDIDA	EUROS
APH12119	25-20	2,13
APH12120	32-25	3,03
APH12121	40-32	4,70
APH12122	50-40	6,65
APH12123	63-50	9,91
APH12124	75-63	17,82
APH12125	90-75	29,31
APH12126	110-90	43,52

ENLACE ROSCA MACHO



REFERENCIA	MEDIDA	EUROS
APH12037	20 X 1/2"	1,04
APH12038	25 X 3/4"	1,25
APH12039	32 X 1"	2,03
APH12040	40 X 1 1/4"	2,76
APH12041	50 X 1 1/2"	3,61
APH12042	63 X 2"	5,51
APH12043	75 X 2 1/2"	9,97
APH12044	90 X 3"	16,15
APH12045	110 X 4"	35,93

ENLACE ROSCA HEMBRA



REFERENCIA	MEDIDA	EUROS
APH12046	20 X 1/2"	1,60
APH12047	25 X 3/4"	1,98
APH12048	32 X 1"	2,55
APH12049	40 X 1 1/4"	3,54
APH12050	50 X 1 1/2"	5,01
APH12051	63 X 2"	7,36
APH12052	75 X 2 1/2"	12,39
APH12053	90 X 3"	19,34
APH12054	110 X 4"	45,02

TE BOCAS IGUALES



REFERENCIA	MEDIDA	EUROS
APH12010	20	2,55
APH12011	25	3,05
APH12012	32	4,30
APH12013	40	6,75
APH12014	50	9,47
APH12015	63	14,18
APH12016	75	29,25
APH12017	90	46,27
APH12018	110	81,17

TE ROSCA HEMBRA



REFERENCIA	MEDIDA	EUROS
APH12057	20 X 1/2"	2,42
APH12058	25 X 3/4"	3,42
APH12059	32 X 1"	4,64
APH12060	40 X 1 1/4"	6,10
APH12061	50 X 1 1/2"	8,69
APH12062	63 X 2"	13,75
APH12063	75 X 2 1/2"	23,93
APH12064	90 X 3"	35,49
APH12065	110 X 4"	74,51

**TE SALIDA
ROSCA MACHO**



REFERENCIA	MEDIDA	EUROS
APH14001	20 X 1/2"	2,55
APH14002	25 X 3/4"	3,20
APH14003	32 X 1"	4,51
APH14004	40 X 1 1/4"	7,04
APH14005	50 X 1 1/2"	9,86
APH14006	63 X 2"	14,90
APH14007	75 X 2 1/2"	29,25
APH14008	90 X 3"	46,27
APH14009	110 X 4"	81,17

TAPÓN FINAL



REFERENCIA	MEDIDA	EUROS
APH12028	20	1,39
APH12029	25	1,64
APH12030	32	2,34
APH12031	40	3,02
APH12032	50	4,30
APH12033	63	5,97
APH12034	75	11,43
APH12035	90	18,68
APH12036	110	37,24

**CODO 90°
ROSCA MACHO**



REFERENCIA	MEDIDA	EUROS
APH14010	20 X 1/2"	1,78
APH14011	25 X 3/4"	2,16
APH14012	32 X 1"	2,66
APH14013	40 X 1 1/4"	3,54
APH14014	50 X 1 1/2"	4,69
APH14015	63 X 2"	6,23
APH14016	75 X 2 1/2"	13,28
APH14017	90 X 3"	26,59
APH14018	110 X 4"	66,55

**CODO 90°
ROSCA HEMBRA**



REFERENCIA	MEDIDA	EUROS
APH12066	20 X 1/2"	1,87
APH12067	25 X 3/4"	2,24
APH12068	32 X 1"	3,18
APH12069	40 X 1 1/4"	4,64
APH12070	50 X 1 1/2"	7,02
APH12071	63 X 2"	8,76
APH12072	75 X 2 1/2"	16,83
APH12073	90 X 3"	27,5
APH12074	110 X 4"	64,41



CODO IGUAL 90°

REFERENCIA	MEDIDA	EUROS
APH12001	20	2,25
APH12002	25	2,53
APH12003	32	3,15
APH12004	40	4,51
APH12005	50	6,29
APH12006	63	9,52
APH12007	75	17,69
APH12008	90	29,65
APH12009	110	69,86

**CODO GRIFO
REFORZADO**



REFERENCIA	MEDIDA	EUROS
APH12170	20 X 1/2"	2,89
APH12171	25 X 3/4"	3,20
APH12172	32 X 1"	4,54
APH12173	40 X 1 1/4"	7,12

**LLAVE
GANCHO FITTING**



REFERENCIA	MEDIDA	EUROS
APH12301	20 X 25/32	13,70
APH12302	40 X 50/63	26,70
APH12303	75 X 90/110	30,43

VÁLVULAS DE BOLA EN PVC

VÁLVULA DE BOLA PVC ENCOLAR





REFERENCIA	MEDIDA	EUROS
VBP1010016	20	5,45
VBP1010020	25	6,62
VBP1010025	32	9,32
VBP1010032	40	9,63
VBP1010040	50	13,82
VBP1010050	63	19,70
VBP1010063	75	88,05
VBP1010075	90	119,81
VBP1010090	110	180,93

VÁLVULA DE BOLA PVC ROSCA HEMBRA

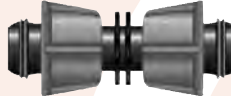

REFERENCIA	MEDIDA	EUROS
VBP1020016	1/2"	5,62
VBP1020020	3/4"	6,66
VBP1020025	1"	9,63
VBP1020032	1 1/4"	10,46
VBP1020040	1 1/2"	14,68
VBP1020050	2"	21,79
VBP1020063	2 1/2"	93,15
VBP1020075	3"	126,41
VBP1020090	4"	192,31

ACCESORIOS PARA RAMALES DE MICROIRRIGACIÓN

CLAHO Fertirrigación	BLOCK SYSTEM	REFERENCIA	D mm	L mm	H mm	Z mm	UN mm	UN pack	M3	KG	EUROS
ENLACE CINTA-TUBO		40101616	16,4	15	59	16	100	1600	0,045	9,3	0,32
ENLACE CINTA-CINTA		402011616	16,4	16,4	62	25	100	1200	0,045	9,7	0,32
ENLACE TUBO-TUBO		40201919	18,6	18,6	62	29	100	800	0,045	7	0,29
INJERTO CTR CINTA		40301610	16,4	10	45	25	100	2000	0,045	9,6	0,29

El sistema patentado "BLOCK SYSTEM" optimiza el tiempo de montaje hasta en un 60%. Permite la conexión y enlace de todos los modelos de CINTAS, GOTEROS INTEGRADOS, y Temperatura de trabajo de -24°C A + 80°C

COLLARINES COMPACTOS EN P.P.F.V.

COLLARÍN SIMPLE REFORZADO



REFERENCIA	MEDIDA	EUROS	REFERENCIA	MEDIDA	EUROS
AP292520	25 - 1/2"	1,27	AP012540	125 - 1 1/4"	9,62
AP292525	25 - 3/4"	1,27	AP012550	125 - 1 1/2"	9,62
AP293220	32 - 1/2"	1,64	AP012563	125 - 2"	9,62
AP293225	32 - 3/4"	1,64	AP012575	125 - 2 1/2"	9,62
AP293232	32 - 1"	1,64	AP014032	140 - 1"	14,57
AP294020	40 - 1/2"	2,04	AP014040	140 - 1 1/4"	14,57
AP294025	40 - 3/4"	2,04	AP014050	140 - 1 1/2"	14,57
AP294032	40 - 1"	2,04	AP014063	140 - 2"	14,57
AP295020	50 - 1/2"	2,07	AP014075	140 - 2 1/2"	14,57
AP295025	50 - 3/4"	2,07	AP014090	140 - 3"	14,57
AP295032	50 - 1"	2,07	AP016032	160 - 1"	16,13
AP295040	50 - 1 1/4"	3,24	AP016040	160 - 1 1/4"	16,13
AP296325	63 - 3/4"	3,24	AP016050	160 - 1 1/2"	16,13
AP296332	63 - 1"	3,24	AP016063	160 - 2 "	16,13
AP296340	63 - 1 1/4"	3,24	AP016075	160 - 2 1/2"	16,13
AP296350	63 - 1 1/2"	3,24	AP016090	160 - 3"	16,13
AP297525	75 - 3/4"	4,71	AP020040	200 - 1 1/4"	57,07
AP297532	75 - 1"	4,71	AP020050	200 - 1 1/2"	57,07
AP297540	75 - 1 1/4"	4,71	AP020063	200 - 2"	57,07
AP297550	75 - 1 1/2"	4,71	AP020075	200 - 2 1/2"	57,07
AP297563	75 - 2"	4,71	AP020090	200 - 3"	57,07
AP299025	90 - 3/4"	5,02	AP020110	200 - 4"	57,07
AP299032	90 - 1"	5,02	AP025050	250 - 1 1/2"	105,66
AP299040	90 - 1 1/4"	5,02	AP025063	250 - 2"	105,66
AP299050	90 - 1 1/2"	5,02	AP025075	250 - 2 1/2"	105,66
AP299063	90 - 2"	5,02	AP025090	250 - 3"	105,66
AP291101	110 - 1 1/4"	6,55	AP025110	250 - 4"	107,13
AP291102	110 - 1 1/2"	6,55	AP031550	315 - 1 1/2"	126,40
AP291103	110 - 2"	6,55	AP031563	315 - 2"	126,40
AP291104	110 - 2 1/2"	6,55	AP031575	315 - 2 1/2"	126,40
AP012525	125 - 3/4"	9,62	AP031590	315 - 3"	126,40
AP012532	125 - 1"	9,62	AP031110	315 - 4"	127,90

CARACTERÍSTICAS TÉCNICAS:

CUERPO: Fabricado en PPVF (Polipropileno con fibra de vidrio)

JUNTA TORICA: Nitrilo NBR-70 SHORE

TORNILLOS Y TUERCAS: Zincadas

MEDIDAS EXTERIORES DE TUBERIAS

DN		TIPO DE TUBERIA			
		PVC - PE Ø exterior	FUNDICIÓN Ø exterior	ACERO Ø exterior	FIBROCEMENTO clase Ø exterior
40	1 1/2"	50			
50	2"	63		60.30	
60	2 1/2"		77		A-F 77
65	2 1/2"	75		76.1/73	
80	3"	90	98	88.90	A-F 101
100	4"	110	118	114.30	A-D 119
125	5"	125	144	139.70	A-D 149
150	6"	160	170	168.30 165.10	A-D 170 E-F 187
175	7"			193.70	
200	8"	200 225	222	219.10	A-C 222 D 232 E-F 249
250	10"	250 280	274	273.10	A-B 272 C 280 D 287 E-F 311
300	12"	315	326	323.90	A-B 326 C 330 D 339 E-F 360
350	14"	355	378	355.60	A-B 380 C 385 D 395 E-F 420
400	16"	400	429	406.40	A-B 434 C 440 D 452 E-F 480
450	18"	450	480	457.20	A-B 488 C 494 D 508 E-F 540
500	20"	500 560	532	508	A-B 543 C 549 D 564 E-F 600
600	24"	630	635	609.60	A-B 651 C 659 D 677 E 705 F 720
700	28"	710	738	711.20	A-B 760 C 769 D 790 E 882 F 840
800	32"	800	842	812.80	A-B 868 C 879 D 903 E 940 F 960
900	36"	900	945	914.40	A-B 978 C 989 D 1015 E 1057 F 1080
1000	40"	1000	1048	1016	A-B 1086 C 1100 D 1128 E 1174 F 1200

